

Základné údaje o výkone - WAMAK AiWa 11 EVI H In

Vykurovanie - EN 14511		
Tepelný výkon [kW]	A7 / W35	12.4
	A2 / W35	10.6
	A-7 / W34	8.8
Elektrický príkon [kW]	A7 / W35	2.5
	A2 / W35	2.6
	A-7 / W34	2.5
Tepelná účinnosť [COP]	A7 / W35	4.85
	A2 / W35	4.12
	A-7 / W34	3.49
Sezónna tepelná účinnosť vykurovania - SCOP EN 14825		
Stredná klim. zóna / Nízka teplota [35°C]	SCOP	4.77
	η [%]	190.9
	Label	A+++
	Qhe [kWh]	4168.8
	Pdesignh [kW]	9.9
	Tbivalent [°C]	-7
Chladenie		
Chladiaci výkon - [kW]	A35 / W23-18	11.5
	A25 / W23-18	12.3
	A35 / W12-7	8.6
	A25 / W12-7	8.6
Sezónna účinnosť chladenia - SEER EN 14825		
[W 23 / 18°C]	SEER	4.69
	Qce [kWh]	5160.0
	η_c [%]	187.5
Zvuk EN 12102		
Zvuk - výkon - Lw	dB(A)	55.9
Zvuk - tlak - Lp	1 m dB(A)	47.9
	5 m dB(A)	33.9
	10 m dB(A)	27.9
Strojné a prevádzkové informácie		
Typ kompresoru (3~ 400/50)	SCROLL / 1 /	Zap/Vyp
Chladivo	R410A (GWP - 2088)	5 kg
Prevádzkové hraničné teploty vykurovania - (min / max) [°C]		25 / 65
Prevádzkové hraničné teploty zdroja - (min / max) [°C]		-22 / 40
Váha zariadenia		270 kg

Hlavné technické údaje - WAMAK AiWa 11 EVI H In

Označenie krytovania			AiWa-I			Údaje strany odovzdania tepelnej energie		
Základné rozmery	Výška [mm]	1760	Prevádzkové hraničné teploty vykurovania	MAX [°C]	65			
	Šírka [mm]	920		MIN [°C]	25			
	Dĺžka [mm]	660		viac vid. diagram prevádzkových limitov				
Váha zariadenia [kg]	270		Kondenzátor	Pripojovacia dimenzia	1 "			
Farba krytovania	Sivá			Typ	BPHE			
IP trieda krytovania	IP44			Počet	1			
Chladivový okruh				Materiál	AISI 316			
Kompresor	Typ	Scroll	Maximálny prevádzkový tlak - chladivo [bar]	45				
	Výkonové stupňe	1	Maximálny prevádzkový tlak - Voda [bar]	6				
	Zap/Vyp		Testovací pretlak [bar]	70				
	Účinník Cosφ	0.79	Teplonosné médium	Voda				
	Odpor vynutia kompresora	3.20 Ohm	Objemový prietok @ dT 5K (nom) - Voda [m3/h]	2.13				
Chladivo		R410A	Vnútorná tlaková strata - Voda [kPa]	12				
	Objem	5 kg	ECM nízkoenergetické čerpadlo spotreby	UPM3 25-75				
	GWP	2088	Snímač prietoku strana spotreby - analog	0..10V				
	Bezpečnostná trieda	A1	Teplotný spád	@ 35°C (nom)	5 K			
Typ oleja v okruhu	POE RL32-3MAF			@ 55°C	8 K			
	Objem oleja	1.25 L		@ 65°C	10 K			
Maximálny tlak chladiva [bar]		45	Údaje strany odberu obnoviteľnej energie					
	PED trieda	1	Prevádzkové hraničné teploty zdroja	MIN [°C]	-22			
EVI - vstrek chladiva s ekonomizérom				MAX [°C]	40			
APS systém podchladenia chladiva			viac vid. diagram prevádzkových limitov					
Reverzibilný chod (chladenie)			Výparník	Pripojovacia dimenzia	700mm x 700mm "			
Reverzibilné odtavenie horúcimi parami				Typ	Cu-coil /Al-fin			
Údaje elektrického pripojenia				Počet	1			
Elektro napájanie [#~ V/Hz]				Materiál	Cu/Al			
Prúd	nominálny [A]	4.28	Maximálny prevádzkový tlak - chladivo [bar]	28				
	maximálny [A]	9.20	Teplonosné médium	Vzduch				
	štartovací [A]	11.55	Objemový prietok - Vzduch [m3/h]	3930				
Softštartér	MCI 12		Vnútorná tlaková strata - Vzduch [kPa]	0.02				
Hlavný istič - charakteristika			Teplotný spád - Vzduch	7 K				
C20			Počet ventilátorov	1				
Riadiaci systém			Priemer ventilátora [mm]	630				
Hlavný regulátor	SIEMENS	RVS 21 AVS 55.199						
Rozširovací modul	AVS75.3xx	AVS75.3xx	AVS75.372					
Bus Clip-In	LPB OCI345	Modbus OCI351						
Online pripojenie	Web server OZW672	ToSyMo						
Regulácia EEV	1 - EEV H/C							

*** s príslušenstvom

WAMAK AiWa 11 EVI H In

ErP (EU) No 811/2013: Technické parametre vykurovacích zariadení s tepelným čerpadlom

Model	AiWa 11 EVI H In
Tepelné čerpadlo vzduch-voda	áno
Tepelné čerpadlo soľanka-voda	nie
Tepelné čerpadlo voda-voda	nie
Nízkotepelné tepelné čerpadlo	nie
Vybavené prídavným ohrievačom	nie
Kombinované tepelné čerpadlo s ohrievačom	nie
Teplotné použitie	nízka teplota (35 °C - 30 °C)
Klimatická oblasť	priemerná

Položka	Symbol	Hodnota	mj	Položka	Symbol	Hodnota	mj
Menovitý tepelný výkon pri Tdesignh	Prated	9.9	kW	Sezónna energetická účinnosť vykurovania priestoru	ηs	190.9	%
Deklarovaný výkon vykurovania pri čiastočnom zaťažení pri vnútornej teplote 20 °C a vonkajšej teplote Tj				Deklarovaný súčiniteľ výkonu alebo pomer primárnej energie pre čiastočné zaťaženie pri vnútornej teplote 20 °C a vonkajšej teplote Tj			
Tj = -7 °C	Pdh	8.8	kW	Tj = -7 °C	COPd	3.49	-
Tj = +2 °C	Pdh	10.6	kW	Tj = +2 °C	COPd	4.7	-
Tj = +7 °C	Pdh	12.3	kW	Tj = +7 °C	COPd	6.1	-
Tj = +12 °C	Pdh	14.3	kW	Tj = +12 °C	COPd	8.2	-
Tj = bivalentná teplota	Pdh	8.5	kW	Tj = bivalentná teplota	COPd	3.3	-
Tj = hraničná prevádzková teplota	Pdh	6.2	kW	Tj = hraničná prevádzková teplota	COPd	2.4	-
Bivalentná teplota	Tbiv	-7	°C	Tj = hraničná prevádzková teplota	TOL	-22	°C
Spotreba energie v iných ako aktívnych režimoch				Medzná prevádzková teplota vykurovacej vody	WTOL	65	°C
Vypnuté	Poff	0.010	kW	Prídavný ohrievač			
Režim vypnutia termostatu	Pto	0.010	kW	Menovitý tepelný výkon	Psup	4.4	kW
Pohotovostný režim	Psb	0.010	kW	Typ príkonu energie	elektrická		
Režim ohrevu kľukovej skrine	Pck	0.020	kW				
Ostatné položky							
Regulácia výkonu	pevná			Pre tepelné čerpadlá vzduch-voda: Menovitý prietok vzduchu, vonku	-	3930	m ³ /h
Úroveň akustického výkonu				Pre tepelné čerpadlá voda-voda alebo soľanka-voda: Menovitý prietok soľanky alebo vody, vonkajší výmenník tepla	-	---	m ³ /h
v interiéri	Lwa	56	dB				
vonku	Lwa	---	dB				
Ročná spotreba energie	QHE	4168.8	kWh				

Kontaktné údaje: WAMAK, s.r.o., Orovnica 252, 96652, Orovnica, Slovakia, info@wamak.sk

WAMAK AiWa 11 EVI H In

ErP (EU) No 811/2013: Technické parametre vykurovacích zariadení s tepelným čerpadlom

Model	AiWa 11 EVI H In
Tepelné čerpadlo vzduch-voda	áno
Tepelné čerpadlo soľanka-voda	nie
Tepelné čerpadlo voda-voda	nie
Nízkotepelné tepelné čerpadlo	nie
Vybavené prídavným ohrievačom	nie
Kombinované tepelné čerpadlo s ohrievačom	nie
Teplotné použitie	stredná teplota (55°C - 47°C)
Klimatická oblasť	priemerná

Položka	Symbol	Hodnota	mj	Položka	Symbol	Hodnota	mj
Menovitý tepelný výkon pri Tdesignh	Prated	10.5	kW	Sezónna energetická účinnosť vykurovania priestoru	η_s	143.7	%
Deklarovaný výkon vykurovania pri čiastočnom zaťažení pri vnútornej teplote 20 °C a vonkajšej teplote Tj				Deklarovaný súčiniteľ výkonu alebo pomer primárnej energie pre čiastočné zaťaženie pri vnútornej teplote 20 °C a vonkajšej teplote Tj			
Tj = -7 °C	Pdh	9.2	kW	Tj = -7 °C	COPd	2.32	-
Tj = +2 °C	Pdh	10.7	kW	Tj = +2 °C	COPd	3.5	-
Tj = +7 °C	Pdh	12.4	kW	Tj = +7 °C	COPd	4.7	-
Tj = +12 °C	Pdh	14.3	kW	Tj = +12 °C	COPd	6.7	-
Tj = bivalentná teplota	Pdh	9.0	kW	Tj = bivalentná teplota	COPd	2.1	-
Tj = hraničná prevádzková teplota	Pdh	7.1	kW	Tj = hraničná prevádzková teplota	COPd	1.7	-
Bivalentná teplota	Tbiv	-7	°C	Tj = hraničná prevádzková teplota	TOL	-22	°C
Spotreba energie v iných ako aktívnych režimoch				Medzná prevádzková teplota vykurovacej vody	WTOL	65	°C
Vypnuté	Poff	0.010	kW	Prídavný ohrievač			
Režim vypnutia termostatu	Pto	0.010	kW	Menovitý tepelný výkon	Psup	4.4	kW
Pohotovostný režim	Psb	0.010	kW	Typ príkonu energie			
Režim ohrevu kľukovej skrine	Pck	0.020	kW	elektrická			
Ostatné položky				Pre tepelné čerpadlá vzduch-voda: Menovitý prietok vzduchu, vonku			
Regulácia výkonu		pevná				3930	m ³ /h
Úroveň akustického výkonu				Pre tepelné čerpadlá voda-voda alebo soľanka-voda: Menovitý prietok soľanky alebo vody, vonkajší výmenník tepla			
v interiéri	Lwa	56	dB			---	m ³ /h
vonku	Lwa	---	dB				
Ročná spotreba energie	Q _{HE}	5922.0	kWh				

Kontaktné údaje: WAMAK, s.r.o., Orovnica 252, 96652, Orovnica, Slovakia, info@wamak.sk



ENERG Y IIA
 енергия - ενεργεια IE IA



AiWa 11 EVI H In



55 °C

35 °C



56 dB

--- dB

■ 12	■ 11
■ 11	■ 10
■ 11	■ 10
kW	kW

2019

811/2013

AiWa 11 EVI H In

ErP Data

	55 °C	35 °C
Energy class	A++	A+++
η [%]	143.7	190.9
P_{rated} [kW]	11	10
Q_{HE} [kWh/y]	5922	4169
SCOP [-]	3.59	4.77
$T_{bivalent}$ [°C]	-7	-7

CONTROLLER



+ QAA55/75 class VII 3.5% ↓
 - QAA55/75 class III 1.5% ↓

Tepelný výkon - prevádzkové dáta

Version: v2024.004-AW

Stredná klim. zóna / Nízka teplota [35°C]

ZHI11K1P-TFM_R410A_1_AW

Prevádzkové podmienky		Qh	P	COP
1	A7 / W30-35	12.4	2.5	4.85
2	A2 / W35	10.6	2.6	4.12
3	A-22 / W35	6.2	2.5	2.45
A	A-7 / W34	8.8	2.5	3.49
B	A2 / W30	10.6	2.3	4.66
C	A7 / W27	12.3	2.0	6.05
D	A12 / W24	14.3	1.7	8.24
E	A-10 / W35	8.5	2.6	3.29
F	A-7 / W34	8.8	2.5	3.49

SCOP DATA EN 14825:2018	
Stredná klim. zóna / Nízka teplota [35°C]	
SCOPon	4.91
SCOPnet	4.95
SCOP	4.77
η [%]	190.93
Label	A+++
Qh [kWh]	20453.40
Pdesignh [kW]	9.9
Tbivalent [°C]	-7.00

Stredná klim. zóna / Stredná teplota [55°C]

Prevádzkové podmienky		Qh	P	COP
1	A7 / W47-55	12.3	4.3	2.88
2	A2 / W55	10.9	4.3	2.53
3	A-22 / W55	7.1	4.0	1.66
A	A-7 / W52	9.2	4.0	2.32
B	A2 / W42	10.7	3.1	3.46
C	A7 / W36	12.4	2.6	4.72
D	A12 / W30	14.3	2.1	6.75
E	A-10 / W55	9.0	4.3	2.11
F	A-7 / W55	9.3	4.3	2.17

SCOP DATA EN 14825:2018	
Stredná klim. zóna / Stredná teplota [55°C]	
SCOPon	3.66
SCOPnet	3.69
SCOP	3.59
η [%]	143.70
Label	A++
Qh [kWh]	21693.00
Pdesignh [kW]	10.5
Tbivalent [°C]	-7.00

Chladiaci výkon - prevádzkové dáta

Nízkoteplotné chladenie W 12 / 7°C

Prevádzkové podmienky		Qc	P	EER
A	A35 / W12-7	8.6	3.2	2.71
B	A30 / W12-7	8.9	2.8	3.19
C	A25 / W12-7	9.2	2.4	3.75
D	A20 / W12-7	9.4	2.1	4.40

SEER DATA EN 14825:2018 [W 12 / 7°C]	
SEERon	3.64
SEER	3.52
Qc [kWh]	5160.00
η [%]	140.89

Plošné chladenie W 23 / 18°C

Prevádzkové podmienky		Qc	P	EER
A	A35 / W23-18	11.5	3.2	3.65
B	A30 / W23-18	11.9	2.5	4.30
C	A25 / W23-18	12.3	2.2	5.05
D	A20 / W23-18	12.7	1.8	5.92

SEER DATA EN 14825:2018 [W 23 / 18°C]	
SEERon	4.90
SEER	4.69
Qc [kWh]	5160.00
η [%]	187.55

Výkonové kryvky - vykurovanie

- Qh-nom-35
- - - Qh-min-35
- - - - - Qh-max-65
- Qh-nom-45
- Qh-nom-55
- Qh-nom-65
- Pratedh-35
- Pratedh-55

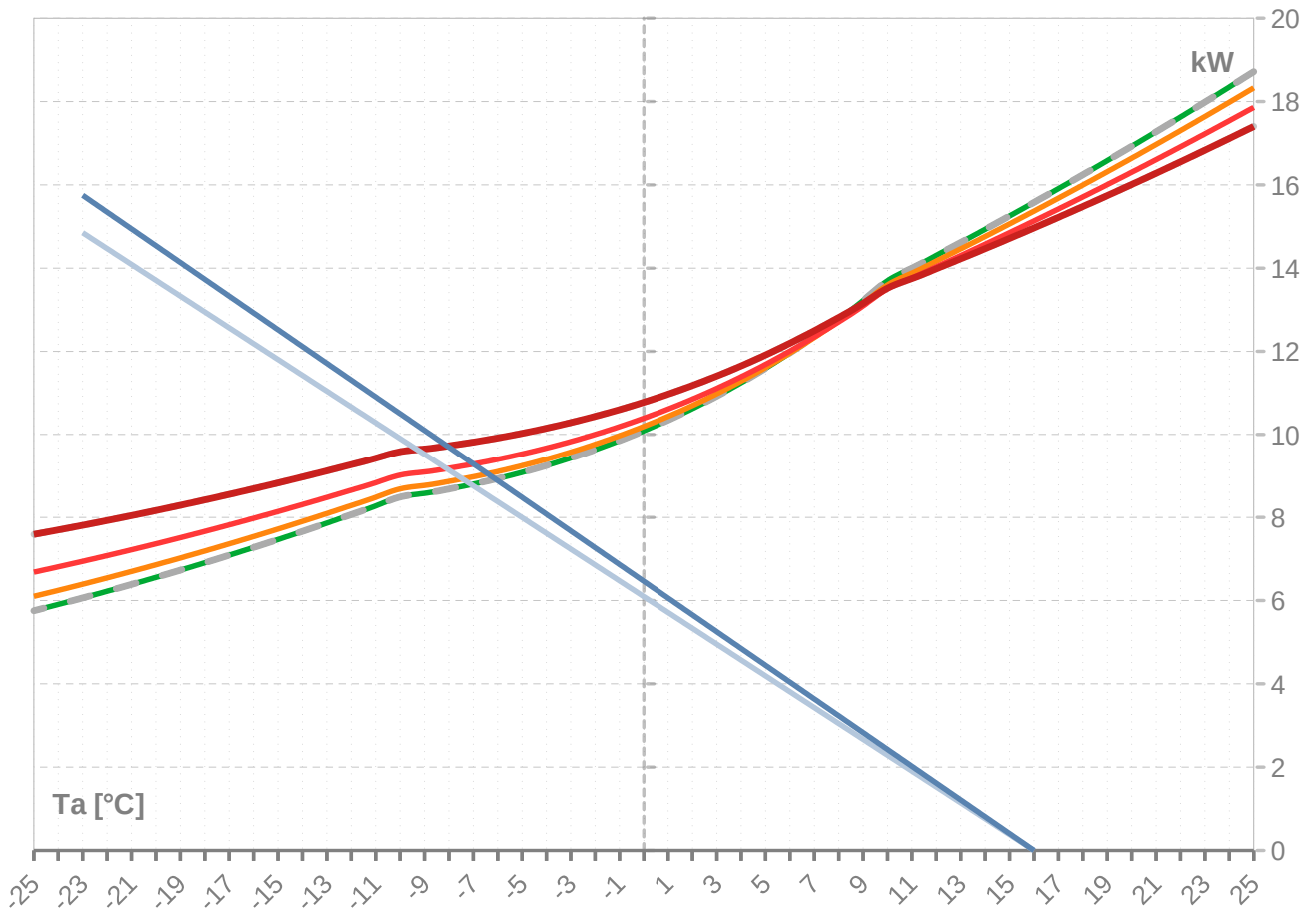

Výkonové kryvky - chladenie

- Pratedc
- Qc-12/7
- Qc-23/18

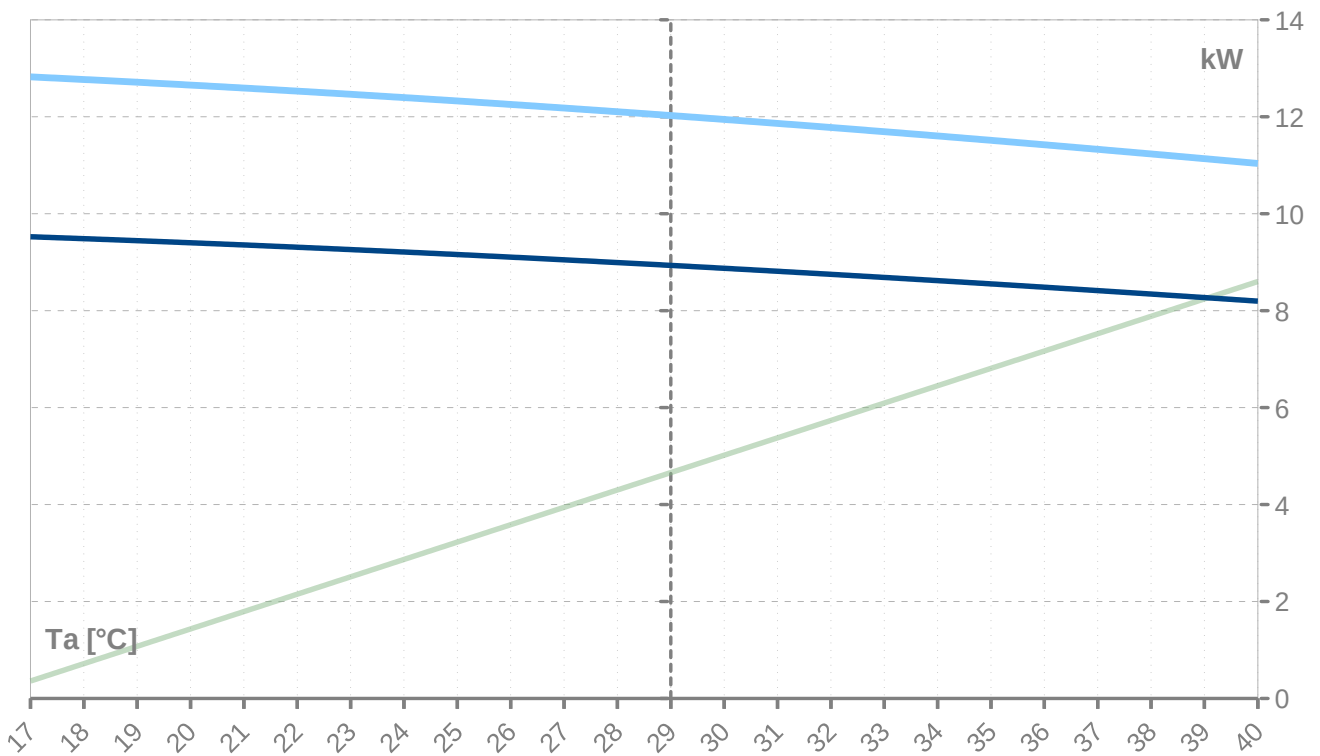

Th [°C]		35 °C								
Ta [°C]	Qh nom [kW]	Qh min [kW]	Qh max [kW]	Pin nom [kW]	Pin-min [kW]	Pin-max [kW]	COP kW / kW	I nom [A]	I min [A]	I max [A]
25	15.9	15.9		2.4	2.4		6.68	4.1	4.1	
24	15.9	15.9		2.4	2.4		6.68	4.1	4.1	
23	15.9	15.9		2.4	2.4		6.68	4.1	4.1	
22	15.9	15.9		2.4	2.4		6.68	4.1	4.1	
21	15.9	15.9		2.4	2.4		6.68	4.1	4.1	
20	15.9	15.9		2.4	2.4		6.68	4.1	4.1	
19	15.9	15.9		2.4	2.4		6.68	4.1	4.1	
18	15.9	15.9		2.4	2.4		6.68	4.1	4.1	
17	15.9	15.9		2.4	2.4		6.68	4.1	4.1	
16	15.6	15.6	15.6	2.4	2.4	2.4	6.49	4.2	4.2	4.2
15	15.3	15.3	15.3	2.4	2.4	2.4	6.30	4.2	4.2	4.2
14	14.9	14.9	14.9	2.4	2.4	2.4	6.12	4.2	4.2	4.2
13	14.6	14.6	14.6	2.5	2.5	2.5	5.95	4.2	4.2	4.2
12	14.3	14.3	14.3	2.5	2.5	2.5	5.79	4.2	4.2	4.2
11	14.0	14.0	14.0	2.5	2.5	2.5	5.63	4.3	4.3	4.3
10	13.7	13.7	13.7	2.5	2.5	2.5	5.48	4.3	4.3	4.3
9	13.2	13.2	13.2	2.5	2.5	2.5	5.25	4.3	4.3	4.3
8	12.8	12.8	12.8	2.5	2.5	2.5	5.04	4.3	4.3	4.3
7	12.4	12.4	12.4	2.5	2.5	2.5	4.85	4.3	4.3	4.3
6	12.0	12.0	12.0	2.6	2.6	2.6	4.68	4.3	4.3	4.3
5	11.6	11.6	11.6	2.6	2.6	2.6	4.52	4.3	4.3	4.3
4	11.2	11.2	11.2	2.6	2.6	2.6	4.37	4.4	4.4	4.4
3	10.9	10.9	10.9	2.6	2.6	2.6	4.24	4.4	4.4	4.4
2	10.6	10.6	10.6	2.6	2.6	2.6	4.12	4.4	4.4	4.4
1	10.3	10.3	10.3	2.6	2.6	2.6	4.00	4.4	4.4	4.4
0	10.1	10.1	10.1	2.6	2.6	2.6	3.90	4.4	4.4	4.4
-1	9.8	9.8	9.8	2.6	2.6	2.6	3.81	4.4	4.4	4.4
-2	9.6	9.6	9.6	2.6	2.6	2.6	3.72	4.4	4.4	4.4
-3	9.4	9.4	9.4	2.6	2.6	2.6	3.65	4.4	4.4	4.4
-4	9.2	9.2	9.2	2.6	2.6	2.6	3.58	4.4	4.4	4.4
-5	9.1	9.1	9.1	2.6	2.6	2.6	3.51	4.4	4.4	4.4
-6	8.9	8.9	8.9	2.6	2.6	2.6	3.46	4.4	4.4	4.4
-7	8.8	8.8	8.8	2.6	2.6	2.6	3.41	4.4	4.4	4.4
-8	8.7	8.7	8.7	2.6	2.6	2.6	3.36	4.4	4.4	4.4
-9	8.6	8.6	8.6	2.6	2.6	2.6	3.32	4.4	4.4	4.4
-10	8.5	8.5	8.5	2.6	2.6	2.6	3.29	4.4	4.4	4.4
-11	8.3	8.3	8.3	2.6	2.6	2.6	3.21	4.4	4.4	4.4
-12	8.1	8.1	8.1	2.6	2.6	2.6	3.13	4.4	4.4	4.4
-13	7.9	7.9	7.9	2.6	2.6	2.6	3.06	4.4	4.4	4.4
-14	7.7	7.7	7.7	2.6	2.6	2.6	2.98	4.3	4.3	4.3
-15	7.5	7.5	7.5	2.6	2.6	2.6	2.91	4.3	4.3	4.3
-16	7.3	7.3	7.3	2.6	2.6	2.6	2.84	4.3	4.3	4.3
-17	7.1	7.1	7.1	2.6	2.6	2.6	2.77	4.3	4.3	4.3
-18	6.9	6.9	6.9	2.6	2.6	2.6	2.70	4.3	4.3	4.3
-19	6.7	6.7	6.7	2.6	2.6	2.6	2.64	4.3	4.3	4.3
-20	6.6	6.6	6.6	2.5	2.5	2.5	2.57	4.3	4.3	4.3
-21	6.4	6.4	6.4	2.5	2.5	2.5	2.51	4.3	4.3	4.3
-22	6.2	6.2	6.2	2.5	2.5	2.5	2.45	4.3	4.3	4.3
-23	6.1	6.1	6.1	2.5	2.5	2.5	2.39	4.3	4.3	4.3
-24	5.9	5.9	5.9	2.5	2.5	2.5	2.33	4.3	4.3	4.3
-25	5.8	5.8	5.8	2.5	2.5	2.5	2.27	4.3	4.3	4.3

* pozor: pracovný rozsah nie je zohľadnený v tabuľke

ZHI11K1P-TFM_R410A_1_AW

Th [°C]		45 °C								
Ta [°C]	Qh nom [kW]	Qh min [kW]	Qh max [kW]	Pin nom [kW]	Pin-min [kW]	Pin-max [kW]	COP kW / kW	I nom [A]	I min [A]	I max [A]
25	18.3	18.3	18.3	3.0	3.0	3.0	6.02	4.9	4.9	4.9
24	18.0	18.0	18.0	3.1	3.1	3.1	5.86	4.9	4.9	4.9
23	17.6	17.6	17.6	3.1	3.1	3.1	5.70	5.0	5.0	5.0
22	17.3	17.3	17.3	3.1	3.1	3.1	5.55	5.0	5.0	5.0
21	17.0	17.0	17.0	3.1	3.1	3.1	5.41	5.0	5.0	5.0
20	16.6	16.6	16.6	3.2	3.2	3.2	5.27	5.0	5.0	5.0
19	16.3	16.3	16.3	3.2	3.2	3.2	5.14	5.1	5.1	5.1
18	16.0	16.0	16.0	3.2	3.2	3.2	5.01	5.1	5.1	5.1
17	15.7	15.7	15.7	3.2	3.2	3.2	4.89	5.1	5.1	5.1
16	15.4	15.4	15.4	3.2	3.2	3.2	4.77	5.1	5.1	5.1
15	15.1	15.1	15.1	3.2	3.2	3.2	4.65	5.1	5.1	5.1
14	14.8	14.8	14.8	3.2	3.2	3.2	4.54	5.1	5.1	5.1
13	14.5	14.5	14.5	3.3	3.3	3.3	4.44	5.2	5.2	5.2
12	14.2	14.2	14.2	3.3	3.3	3.3	4.33	5.2	5.2	5.2
11	13.9	13.9	13.9	3.3	3.3	3.3	4.23	5.2	5.2	5.2
10	13.6	13.6	13.6	3.3	3.3	3.3	4.14	5.2	5.2	5.2
9	13.1	13.1	13.1	3.3	3.3	3.3	3.99	5.2	5.2	5.2
8	12.7	12.7	12.7	3.3	3.3	3.3	3.85	5.2	5.2	5.2
7	12.3	12.3	12.3	3.3	3.3	3.3	3.72	5.2	5.2	5.2
6	12.0	12.0	12.0	3.3	3.3	3.3	3.61	5.2	5.2	5.2
5	11.6	11.6	11.6	3.3	3.3	3.3	3.50	5.2	5.2	5.2
4	11.3	11.3	11.3	3.3	3.3	3.3	3.40	5.2	5.2	5.2
3	11.0	11.0	11.0	3.3	3.3	3.3	3.30	5.2	5.2	5.2
2	10.7	10.7	10.7	3.3	3.3	3.3	3.22	5.2	5.2	5.2
1	10.4	10.4	10.4	3.3	3.3	3.3	3.14	5.2	5.2	5.2
0	10.2	10.2	10.2	3.3	3.3	3.3	3.07	5.2	5.2	5.2
-1	10.0	10.0	10.0	3.3	3.3	3.3	3.00	5.2	5.2	5.2
-2	9.8	9.8	9.8	3.3	3.3	3.3	2.94	5.2	5.2	5.2
-3	9.6	9.6	9.6	3.3	3.3	3.3	2.89	5.2	5.2	5.2
-4	9.4	9.4	9.4	3.3	3.3	3.3	2.84	5.2	5.2	5.2
-5	9.2	9.2	9.2	3.3	3.3	3.3	2.79	5.2	5.2	5.2
-6	9.1	9.1	9.1	3.3	3.3	3.3	2.75	5.2	5.2	5.2
-7	9.0	9.0	9.0	3.3	3.3	3.3	2.71	5.2	5.2	5.2
-8	8.9	8.9	8.9	3.3	3.3	3.3	2.68	5.2	5.2	5.2
-9	8.8	8.8	8.8	3.3	3.3	3.3	2.65	5.2	5.2	5.2
-10	8.7	8.7	8.7	3.3	3.3	3.3	2.63	5.2	5.2	5.2
-11	8.5	8.5	8.5	3.3	3.3	3.3	2.57	5.2	5.2	5.2
-12	8.3	8.3	8.3	3.3	3.3	3.3	2.51	5.2	5.2	5.2
-13	8.1	8.1	8.1	3.3	3.3	3.3	2.45	5.2	5.2	5.2
-14	7.9	7.9	7.9	3.3	3.3	3.3	2.40	5.2	5.2	5.2
-15	7.7	7.7	7.7	3.3	3.3	3.3	2.35	5.2	5.2	5.2
-16	7.5	7.5	7.5	3.3	3.3	3.3	2.29	5.2	5.2	5.2
-17	7.4	7.4	7.4	3.3	3.3	3.3	2.24	5.2	5.2	5.2
-18	7.2	7.2	7.2	3.3	3.3	3.3	2.19	5.2	5.2	5.2
-19	7.0	7.0	7.0	3.3	3.3	3.3	2.14	5.2	5.2	5.2
-20	6.9	6.9	6.9	3.3	3.3	3.3	2.09	5.2	5.2	5.2
-21	6.7	6.7	6.7	3.3	3.3	3.3	2.04	5.2	5.2	5.2
-22	6.5	6.5	6.5	3.3	3.3	3.3	2.00	5.2	5.2	5.2
-23	6.4	6.4	6.4	3.3	3.3	3.3	1.95	5.2	5.2	5.2
-24	6.2	6.2	6.2	3.3	3.3	3.3	1.91	5.2	5.2	5.2
-25	6.1	6.1	6.1	3.3	3.3	3.3	1.86	5.2	5.2	5.2

* pozor: pracovný rozsah nie je zohľadnený v tabuľke

Th [°C]		55 °C								
Ta [°C]	Qh nom [kW]	Qh min [kW]	Qh max [kW]	Pin nom [kW]	Pin-min [kW]	Pin-max [kW]	COP kW / kW	I nom [A]	I min [A]	I max [A]
25	17.9	17.9	17.9	4.1	4.1	4.1	4.35	6.2	6.2	6.2
24	17.5	17.5	17.5	4.1	4.1	4.1	4.25	6.2	6.2	6.2
23	17.2	17.2	17.2	4.1	4.1	4.1	4.15	6.3	6.3	6.3
22	16.9	16.9	16.9	4.2	4.2	4.2	4.06	6.3	6.3	6.3
21	16.6	16.6	16.6	4.2	4.2	4.2	3.98	6.3	6.3	6.3
20	16.3	16.3	16.3	4.2	4.2	4.2	3.89	6.3	6.3	6.3
19	16.0	16.0	16.0	4.2	4.2	4.2	3.81	6.3	6.3	6.3
18	15.7	15.7	15.7	4.2	4.2	4.2	3.73	6.4	6.4	6.4
17	15.4	15.4	15.4	4.2	4.2	4.2	3.65	6.4	6.4	6.4
16	15.1	15.1	15.1	4.2	4.2	4.2	3.57	6.4	6.4	6.4
15	14.9	14.9	14.9	4.2	4.2	4.2	3.50	6.4	6.4	6.4
14	14.6	14.6	14.6	4.3	4.3	4.3	3.43	6.4	6.4	6.4
13	14.3	14.3	14.3	4.3	4.3	4.3	3.36	6.4	6.4	6.4
12	14.0	14.0	14.0	4.3	4.3	4.3	3.29	6.4	6.4	6.4
11	13.8	13.8	13.8	4.3	4.3	4.3	3.22	6.4	6.4	6.4
10	13.5	13.5	13.5	4.3	4.3	4.3	3.16	6.4	6.4	6.4
9	13.1	13.1	13.1	4.3	4.3	4.3	3.06	6.4	6.4	6.4
8	12.7	12.7	12.7	4.3	4.3	4.3	2.96	6.4	6.4	6.4
7	12.3	12.3	12.3	4.3	4.3	4.3	2.88	6.4	6.4	6.4
6	12.0	12.0	12.0	4.3	4.3	4.3	2.80	6.5	6.5	6.5
5	11.7	11.7	11.7	4.3	4.3	4.3	2.72	6.5	6.5	6.5
4	11.4	11.4	11.4	4.3	4.3	4.3	2.65	6.5	6.5	6.5
3	11.1	11.1	11.1	4.3	4.3	4.3	2.59	6.5	6.5	6.5
2	10.9	10.9	10.9	4.3	4.3	4.3	2.53	6.5	6.5	6.5
1	10.6	10.6	10.6	4.3	4.3	4.3	2.47	6.4	6.4	6.4
0	10.4	10.4	10.4	4.3	4.3	4.3	2.42	6.4	6.4	6.4
-1	10.2	10.2	10.2	4.3	4.3	4.3	2.38	6.4	6.4	6.4
-2	10.0	10.0	10.0	4.3	4.3	4.3	2.33	6.4	6.4	6.4
-3	9.8	9.8	9.8	4.3	4.3	4.3	2.29	6.4	6.4	6.4
-4	9.7	9.7	9.7	4.3	4.3	4.3	2.26	6.4	6.4	6.4
-5	9.5	9.5	9.5	4.3	4.3	4.3	2.23	6.4	6.4	6.4
-6	9.4	9.4	9.4	4.3	4.3	4.3	2.20	6.4	6.4	6.4
-7	9.3	9.3	9.3	4.3	4.3	4.3	2.17	6.4	6.4	6.4
-8	9.2	9.2	9.2	4.3	4.3	4.3	2.15	6.4	6.4	6.4
-9	9.1	9.1	9.1	4.3	4.3	4.3	2.13	6.4	6.4	6.4
-10	9.0	9.0	9.0	4.3	4.3	4.3	2.11	6.4	6.4	6.4
-11	8.8	8.8	8.8	4.3	4.3	4.3	2.07	6.4	6.4	6.4
-12	8.7	8.7	8.7	4.3	4.3	4.3	2.03	6.4	6.4	6.4
-13	8.5	8.5	8.5	4.3	4.3	4.3	1.99	6.4	6.4	6.4
-14	8.3	8.3	8.3	4.3	4.3	4.3	1.95	6.4	6.4	6.4
-15	8.1	8.1	8.1	4.3	4.3	4.3	1.91	6.4	6.4	6.4
-16	8.0	8.0	8.0	4.3	4.3	4.3	1.87	6.4	6.4	6.4
-17	7.8	7.8	7.8	4.3	4.3	4.3	1.83	6.4	6.4	6.4
-18	7.7	7.7	7.7	4.3	4.3	4.3	1.80	6.4	6.4	6.4
-19	7.5	7.5	7.5	4.3	4.3	4.3	1.76	6.4	6.4	6.4
-20	7.4	7.4	7.4	4.3	4.3	4.3	1.72	6.4	6.4	6.4
-21	7.2	7.2	7.2	4.3	4.3	4.3	1.69	6.4	6.4	6.4
-22	7.1	7.1	7.1	4.3	4.3	4.3	1.66	6.4	6.4	6.4
-23	6.9	6.9	6.9	4.3	4.3	4.3	1.62	6.4	6.4	6.4
-24	6.8	6.8	6.8	4.3	4.3	4.3	1.59	6.4	6.4	6.4
-25	6.7	6.7	6.7	4.3	4.3	4.3	1.56	6.4	6.4	6.4

* pozor: pracovný rozsah nie je zohľadnený v tabuľke

Th [°C]		T-Max @ 65 °C								
Ta [°C]	Qh nom [kW]	Qh min [kW]	Qh max [kW]	Pin nom [kW]	Pin-min [kW]	Pin-max [kW]	COP kW / kW	I nom [A]	I min [A]	I max [A]
25	17.4	17.4	17.4	5.4	5.4	5.4	3.21	8.0	8.0	8.0
24	17.1	17.1	17.1	5.4	5.4	5.4	3.15	8.0	8.0	8.0
23	16.8	16.8	16.8	5.5	5.5	5.5	3.09	8.0	8.0	8.0
22	16.6	16.6	16.6	5.5	5.5	5.5	3.03	8.0	8.0	8.0
21	16.3	16.3	16.3	5.5	5.5	5.5	2.97	8.0	8.0	8.0
20	16.0	16.0	16.0	5.5	5.5	5.5	2.92	8.0	8.0	8.0
19	15.7	15.7	15.7	5.5	5.5	5.5	2.87	8.1	8.1	8.1
18	15.5	15.5	15.5	5.5	5.5	5.5	2.81	8.1	8.1	8.1
17	15.2	15.2	15.2	5.5	5.5	5.5	2.76	8.1	8.1	8.1
16	15.0	15.0	15.0	5.5	5.5	5.5	2.71	8.1	8.1	8.1
15	14.7	14.7	14.7	5.5	5.5	5.5	2.66	8.1	8.1	8.1
14	14.5	14.5	14.5	5.5	5.5	5.5	2.62	8.1	8.1	8.1
13	14.2	14.2	14.2	5.5	5.5	5.5	2.57	8.1	8.1	8.1
12	14.0	14.0	14.0	5.5	5.5	5.5	2.53	8.1	8.1	8.1
11	13.7	13.7	13.7	5.5	5.5	5.5	2.48	8.1	8.1	8.1
10	13.5	13.5	13.5	5.5	5.5	5.5	2.44	8.1	8.1	8.1
9	13.2	13.2	13.2	5.5	5.5	5.5	2.37	8.1	8.1	8.1
8	12.8	12.8	12.8	5.5	5.5	5.5	2.31	8.1	8.1	8.1
7	12.5	12.5	12.5	5.6	5.6	5.6	2.25	8.1	8.1	8.1
6	12.2	12.2	12.2	5.6	5.6	5.6	2.20	8.1	8.1	8.1
5	11.9	11.9	11.9	5.6	5.6	5.6	2.15	8.1	8.1	8.1
4	11.7	11.7	11.7	5.6	5.6	5.6	2.10	8.1	8.1	8.1
3	11.4	11.4	11.4	5.6	5.6	5.6	2.05	8.1	8.1	8.1
2	11.2	11.2	11.2	5.6	5.6	5.6	2.01	8.1	8.1	8.1
1	11.0	11.0	11.0	5.6	5.6	5.6	1.98	8.1	8.1	8.1
0	10.8	10.8	10.8	5.6	5.6	5.6	1.94	8.1	8.1	8.1
-1	10.6	10.6	10.6	5.6	5.6	5.6	1.91	8.1	8.1	8.1
-2	10.4	10.4	10.4	5.6	5.6	5.6	1.88	8.1	8.1	8.1
-3	10.3	10.3	10.3	5.6	5.6	5.6	1.85	8.1	8.1	8.1
-4	10.1	10.1	10.1	5.6	5.6	5.6	1.83	8.1	8.1	8.1
-5	10.0	10.0	10.0	5.6	5.6	5.6	1.80	8.1	8.1	8.1
-6	9.9	9.9	9.9	5.6	5.6	5.6	1.78	8.1	8.1	8.1
-7	9.8	9.8	9.8	5.6	5.6	5.6	1.77	8.1	8.1	8.1
-8	9.7	9.7	9.7	5.6	5.6	5.6	1.75	8.1	8.1	8.1
-9	9.6	9.6	9.6	5.6	5.6	5.6	1.74	8.1	8.1	8.1
-10	9.6	9.6	9.6	5.6	5.6	5.6	1.72	8.1	8.1	8.1
-11	9.4	9.4	9.4	5.6	5.6	5.6	1.70	8.1	8.1	8.1
-12	9.3	9.3	9.3	5.6	5.6	5.6	1.67	8.1	8.1	8.1
-13	9.1	9.1	9.1	5.6	5.6	5.6	1.64	8.1	8.1	8.1
-14	9.0	9.0	9.0	5.6	5.6	5.6	1.61	8.1	8.1	8.1
-15	8.8	8.8	8.8	5.6	5.6	5.6	1.59	8.1	8.1	8.1
-16										
-17										
-18										
-19										
-20										
-21										
-22										
-23										
-24										
-25										

* pozor: pracovný rozsah nie je zohľadnený v tabuľke

Tc [°C]		W 12 / 7 °C								
Ta [°C]	Qc nom [kW]	Qc min [kW]	Qc max [kW]	Pin [kW]	Pin min [kW]	Pin max [kW]	EER kW / kW	I nom [A]	I min [A]	I max [A]
40	8.2	8.2	8.2	3.6	3.6	3.6	2.29	5.6	5.6	5.6
39	8.3	8.3	8.3	3.5	3.5	3.5	2.37	5.4	5.4	5.4
38	8.3	8.3	8.3	3.4	3.4	3.4	2.45	5.3	5.3	5.3
37	8.4	8.4	8.4	3.3	3.3	3.3	2.53	5.2	5.2	5.2
36	8.5	8.5	8.5	3.2	3.2	3.2	2.62	5.1	5.1	5.1
35	8.6	8.6	8.6	3.2	3.2	3.2	2.71	5.0	5.0	5.0
34	8.6	8.6	8.6	3.1	3.1	3.1	2.80	4.9	4.9	4.9
33	8.7	8.7	8.7	3.0	3.0	3.0	2.90	4.8	4.8	4.8
32	8.7	8.7	8.7	2.9	2.9	2.9	2.99	4.8	4.8	4.8
31	8.8	8.8	8.8	2.9	2.9	2.9	3.09	4.7	4.7	4.7
30	8.9	8.9	8.9	2.8	2.8	2.8	3.19	4.6	4.6	4.6
29	8.9	8.9	8.9	2.7	2.7	2.7	3.30	4.5	4.5	4.5
28	9.0	9.0	9.0	2.6	2.6	2.6	3.41	4.4	4.4	4.4
27	9.0	9.0	9.0	2.6	2.6	2.6	3.52	4.3	4.3	4.3
26	9.1	9.1	9.1	2.5	2.5	2.5	3.63	4.3	4.3	4.3
25	9.2	9.2	9.2	2.4	2.4	2.4	3.75	4.2	4.2	4.2
24	9.2	9.2	9.2	2.4	2.4	2.4	3.87	4.1	4.1	4.1
23	9.3	9.3	9.3	2.3	2.3	2.3	4.00	4.1	4.1	4.1
22	9.3	9.3	9.3	2.3	2.3	2.3	4.13	4.0	4.0	4.0
21	9.4	9.4	9.4	2.2	2.2	2.2	4.26	3.9	3.9	3.9
20	9.4	9.4	9.4	2.1	2.1	2.1	4.40	3.9	3.9	3.9
19	9.4	9.4	9.4	2.1	2.1	2.1	4.54	3.8	3.8	3.8
18	9.5	9.5	9.5	2.0	2.0	2.0	4.69	3.7	3.7	3.7
17	9.5	9.5	9.5	2.0	2.0	2.0	4.84	3.7	3.7	3.7

Tc [°C]		W 23 / 18 °C								
Ta [°C]	Qc [kW]	Qh-min [kW]	Qh-max [kW]	Pin [kW]	Pin-min [kW]	Pin-max [kW]	EER kW / kW	I [A]	I-min [A]	I-max [A]
40	11.0	11.0	11.0	3.6	3.6	3.6	3.08	5.5	5.5	5.5
39	11.1	11.1	11.1	3.5	3.5	3.5	3.19	5.4	5.4	5.4
38	11.2	11.2	11.2	3.4	3.4	3.4	3.30	5.3	5.3	5.3
37	11.3	11.3	11.3	3.3	3.3	3.3	3.41	5.2	5.2	5.2
36	11.4	11.4	11.4	3.2	3.2	3.2	3.53	5.1	5.1	5.1
35	11.5	11.5	11.5	3.2	3.2	3.2	3.65	5.0	5.0	5.0
34	11.6	11.6	11.6	3.1	3.1	3.1	3.77	4.9	4.9	4.9
33	11.7	11.7	11.7	3.0	3.0	3.0	3.90	4.8	4.8	4.8
32	11.8	11.8	11.8	2.9	2.9	2.9	4.03	4.7	4.7	4.7
31	11.9	11.9	11.9	2.9	2.9	2.9	4.16	4.6	4.6	4.6
30	11.9	11.9	11.9	2.8	2.8	2.8	4.30	4.5	4.5	4.5
29	12.0	12.0	12.0	2.7	2.7	2.7	4.44	4.4	4.4	4.4
28	12.1	12.1	12.1	2.6	2.6	2.6	4.59	4.3	4.3	4.3
27	12.2	12.2	12.2	2.6	2.6	2.6	4.74	4.2	4.2	4.2
26	12.3	12.3	12.3	2.5	2.5	2.5	4.89	4.2	4.2	4.2
25	12.3	12.3	12.3	2.4	2.4	2.4	5.05	4.1	4.1	4.1
24	12.4	12.4	12.4	2.4	2.4	2.4	5.21	4.0	4.0	4.0
23	12.5	12.5	12.5	2.3	2.3	2.3	5.38	3.9	3.9	3.9
22	12.5	12.5	12.5	2.3	2.3	2.3	5.55	3.9	3.9	3.9
21	12.6	12.6	12.6	2.2	2.2	2.2	5.73	3.8	3.8	3.8
20	12.7	12.7	12.7	2.1	2.1	2.1	5.92	3.7	3.7	3.7
19	12.7	12.7	12.7	2.1	2.1	2.1	6.11	3.6	3.6	3.6
18	12.8	12.8	12.8	2.0	2.0	2.0	6.31	3.6	3.6	3.6
17	12.8	12.8	12.8	2.0	2.0	2.0	6.52	3.5	3.5	3.5

* pozor: pracovný rozsah nie je zohľadnený v tabuľke

LEGENDE:

Tz-VS: Teplota zdroja - vstup [°C]

Tv-VY: Teplota vykurovania - výstup [°C]

Tch-VY: Teplota chladenia - výstup [°C]

Qh nom: Nominálny tepelný výkon

Qh min: Minimálny tepelný výkon

Qh max: Maxmálny tepelný výkon

Pin nom: Príkonnosť pri nominálnom tepelnom výkone

Pin min: Príkonnosť pri minimálnom tepelnom výkone

Pin max: Príkonnosť pri maximálnom tepelnom výkone

COP nom: Koeficient účinnosti pri nominálnom tepelnom výkone

Qc nom: Chladiaci výkon / odobrané teplo pri nominálnom tepelnom výkone

Qc min: Chladiaci výkon / odobrané teplo pri minimálnom tepelnom výkone

Qc max: Chladiaci výkon / odobrané teplo pri maximálnom tepelnom výkone

I nom: Prúd pri nominálnom tepelnom výkone

EER: Koeficient účinnosti pri nominálnom chladiacom výkone

Prevádzkové limity

°C

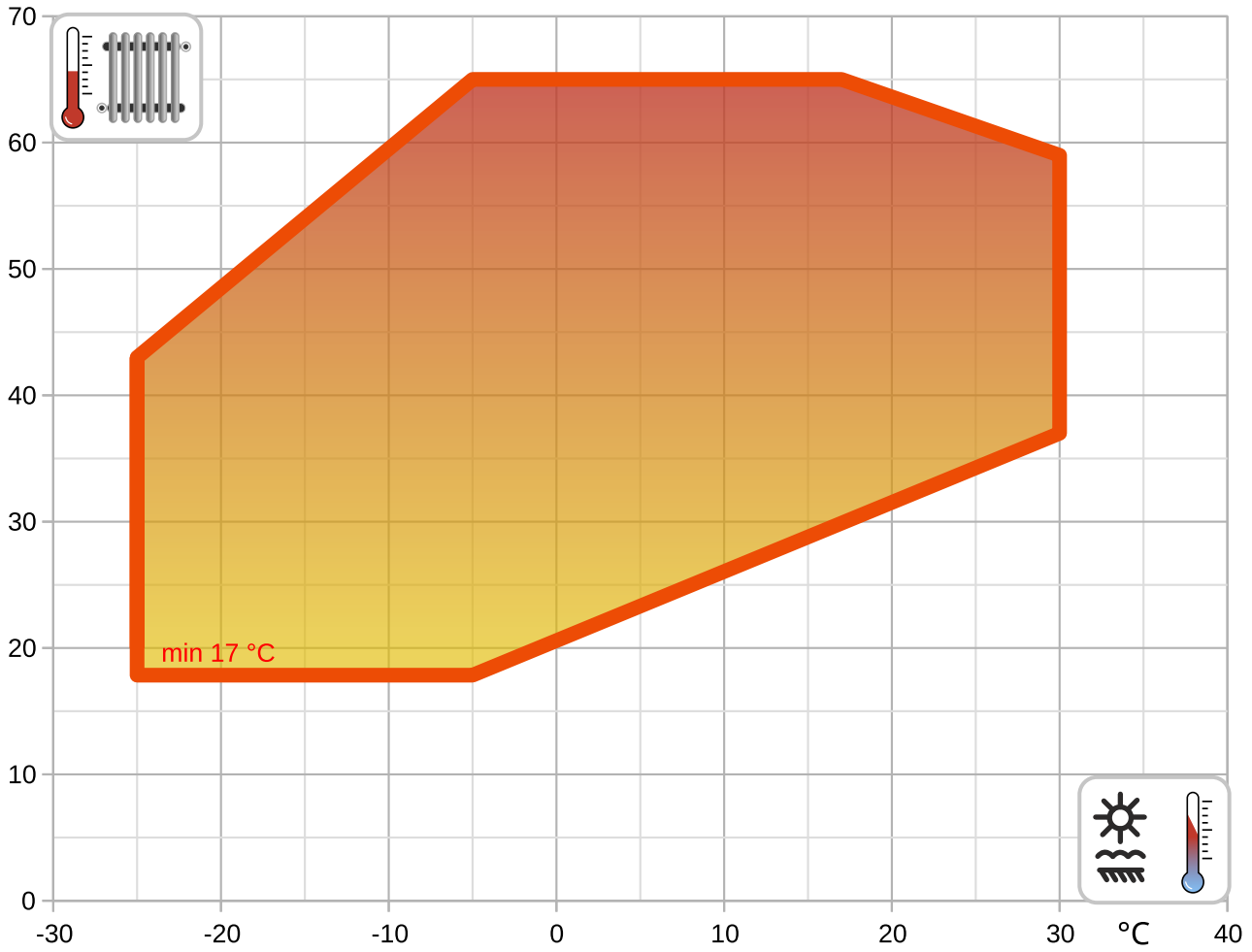

°C

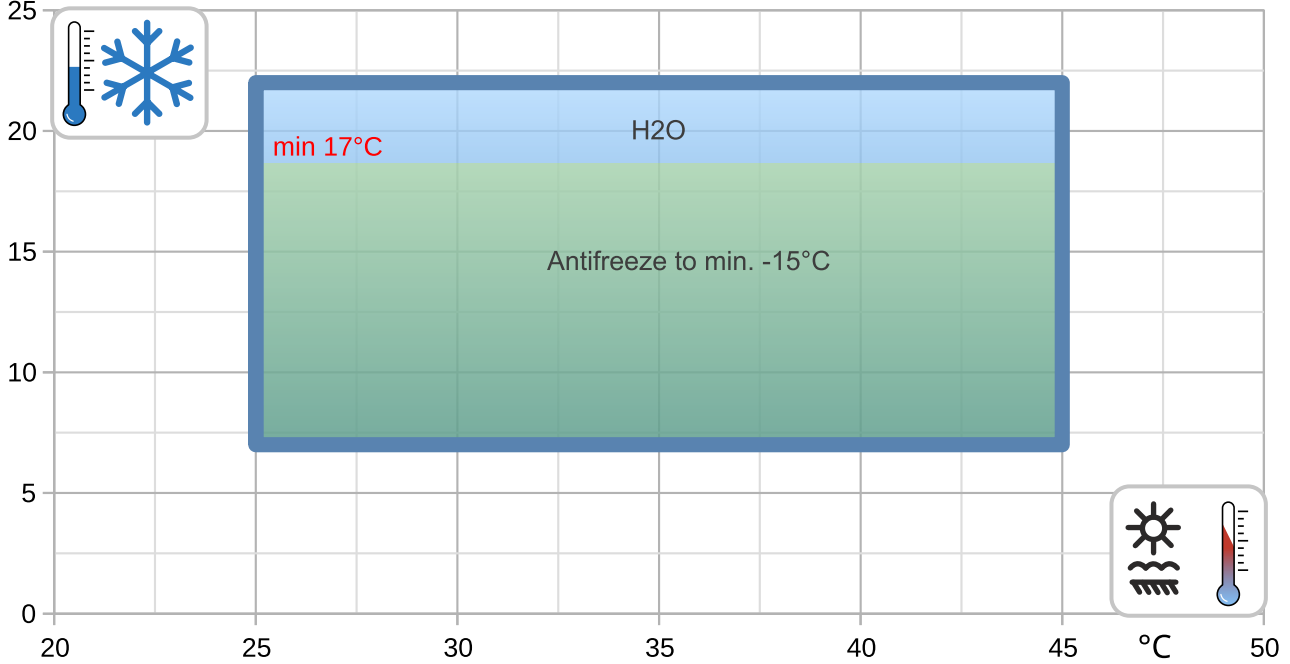

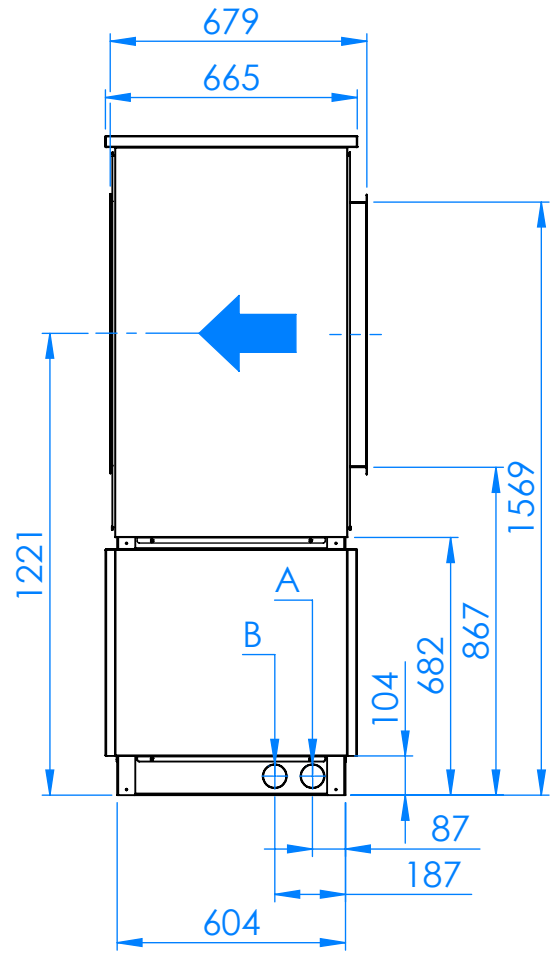
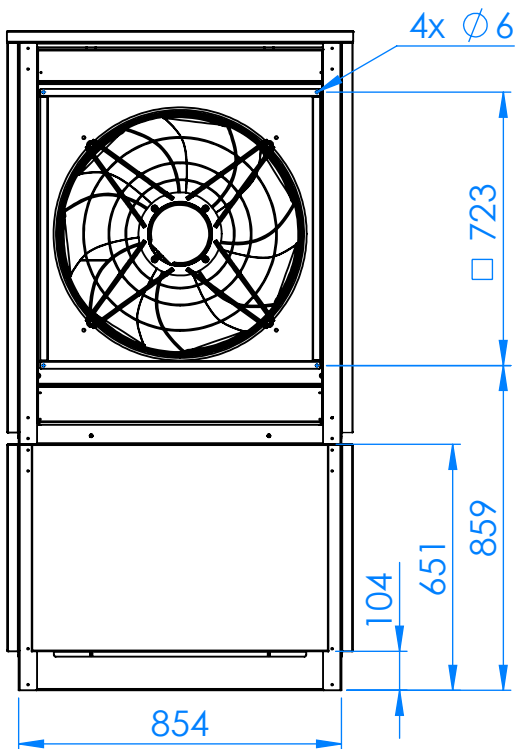
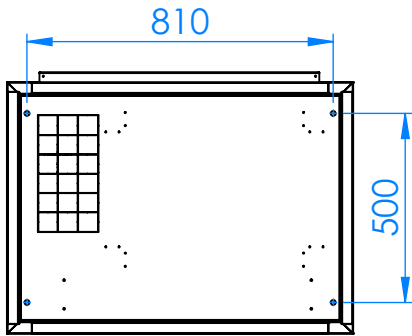
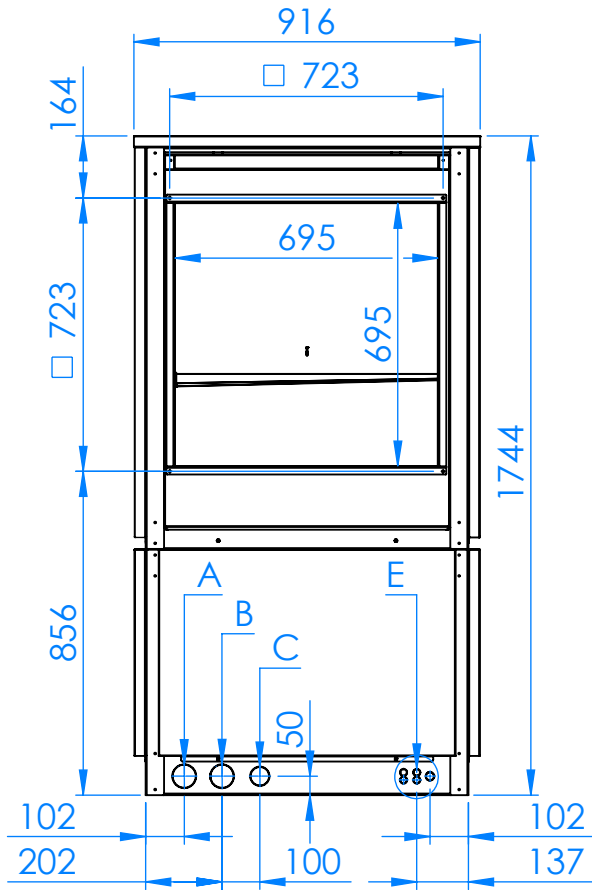

C - condens

E - electro

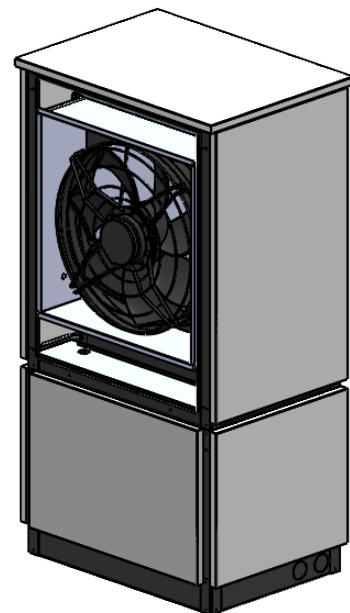

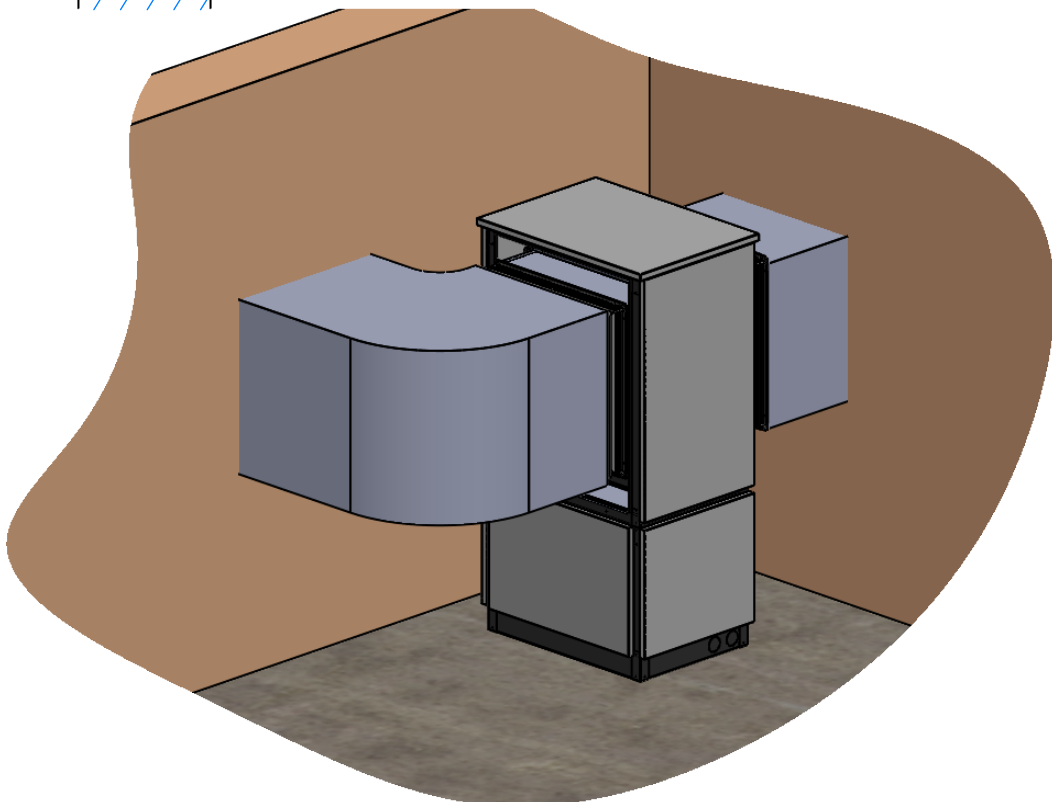
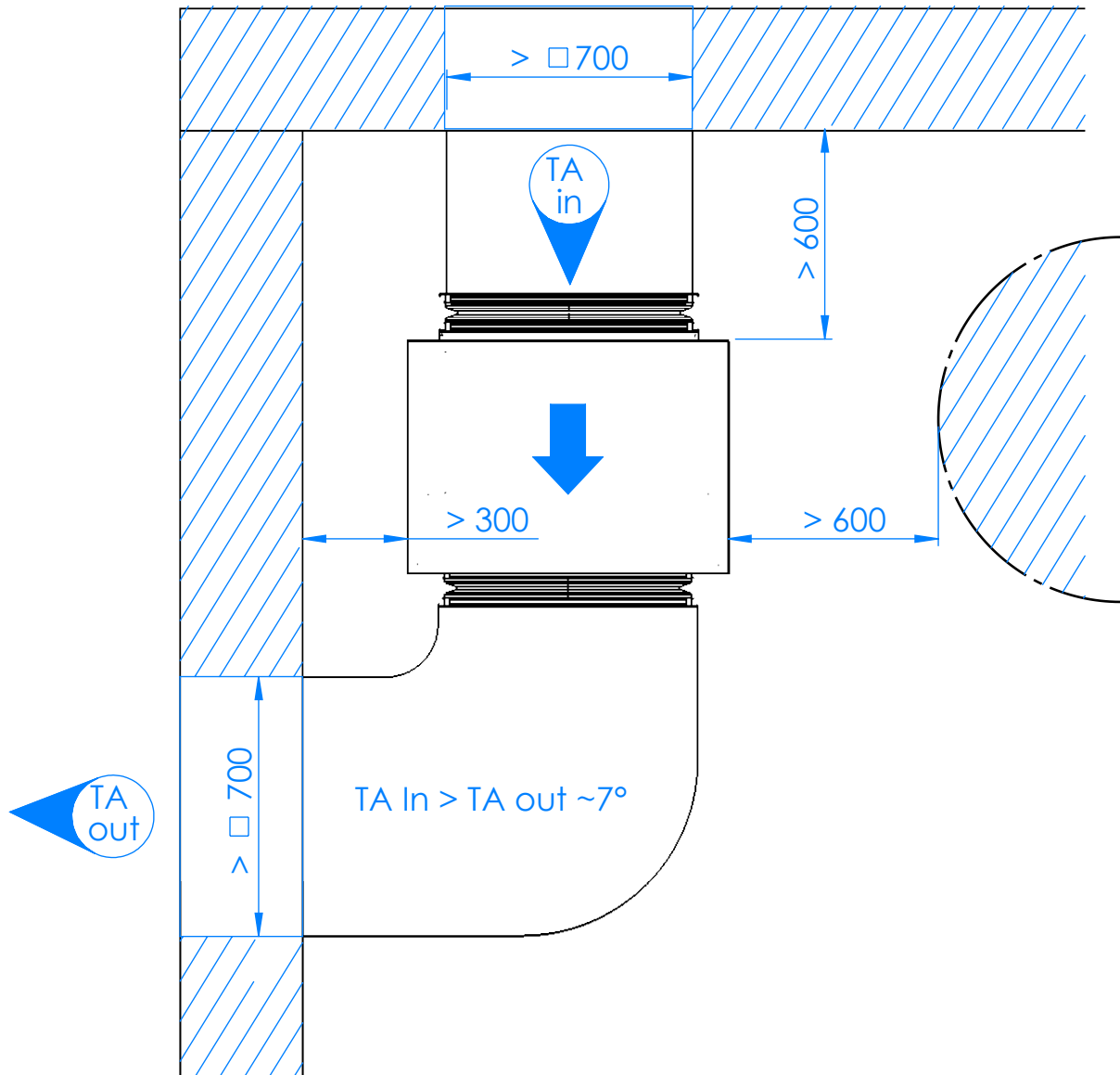

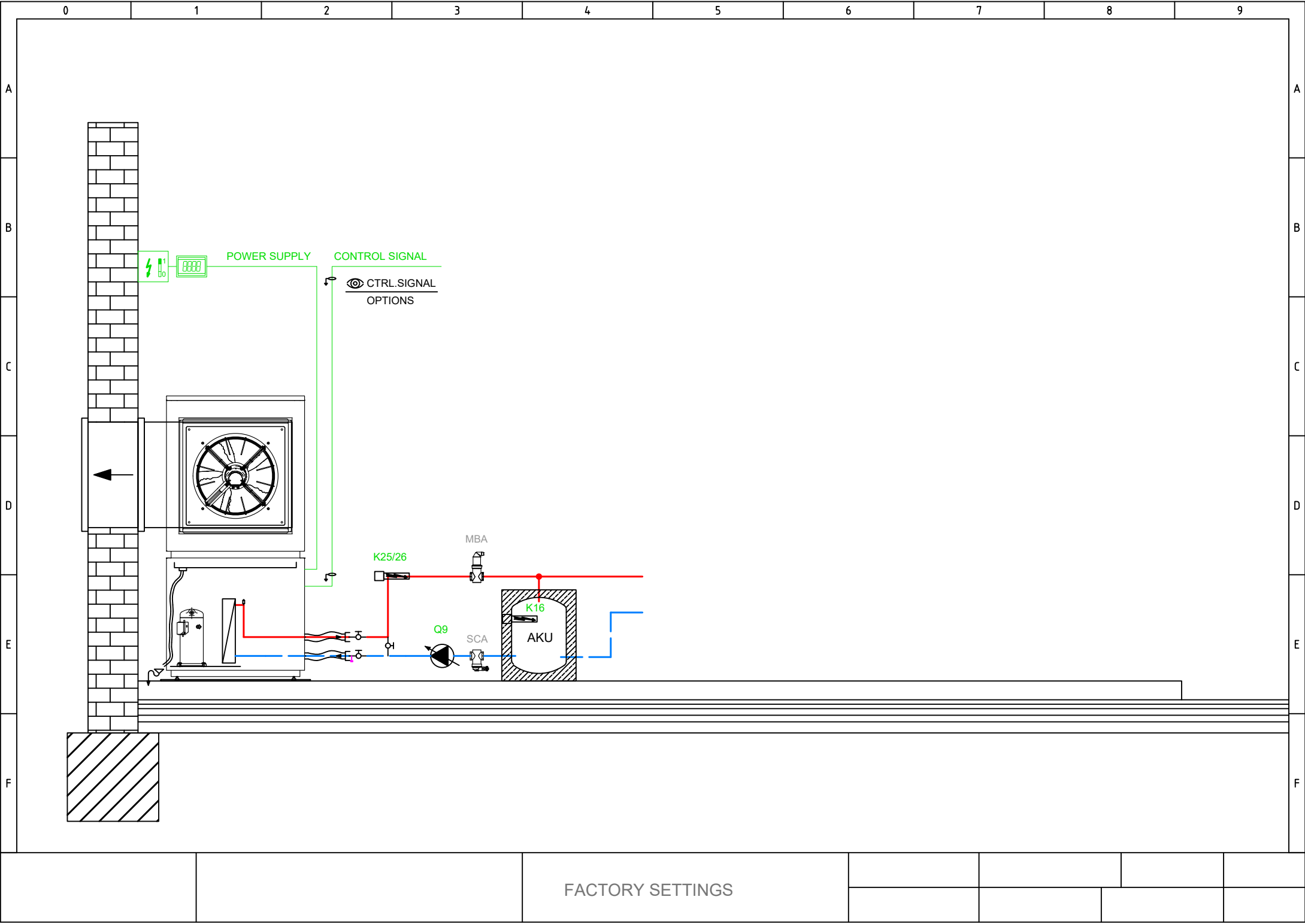

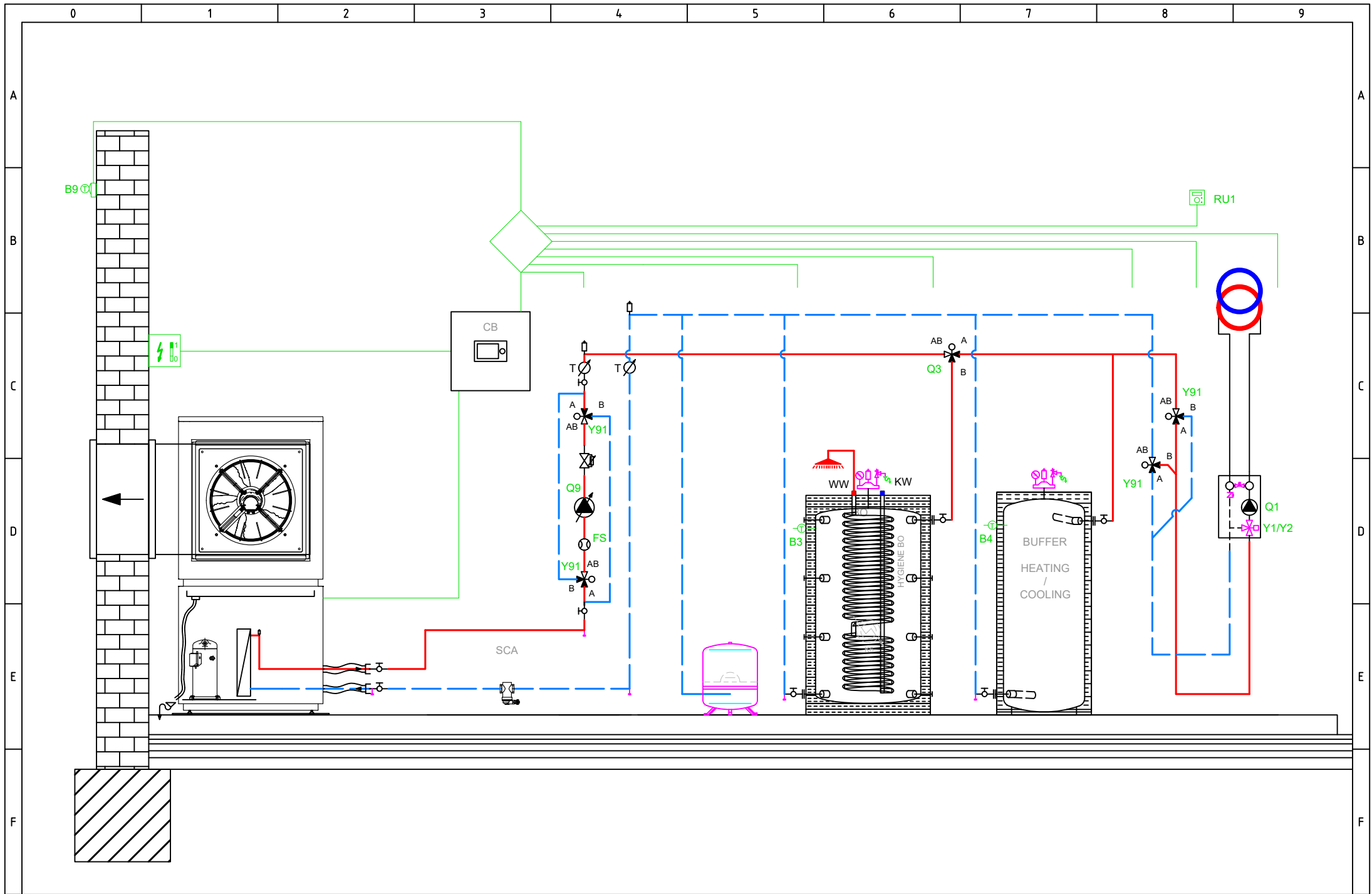

OPTIONAL APPLICATION



Hlavné napájanie 230V / 50 Hz
 Uzemnenie
 Nulový vodič

- E10 Spínač vysokého tlaku E10
- E11 Preťaženie kompresora E11
- E14 Preťaženie zdroja E14
- E24 Spínač prietoku spotreby E24
- K82 Ventil EVI K82

K40 Ohrev oleja K40

- L Fáza 230V
- K1 Kompresor I. stupeň K1
- Y22 Reverzný ventil Y22

Q9 Čerpadlo kondenzátora Q9

X10	1	L
X10	1	PE
X10	1	N
X11	1	EX1
X11	1	EX2
X11	1	EX3
X11	1	EX4
X12	1	QX1
X12	1	N
X12	1	QX2
X12	1	QX2i
X12	1	N
X12	1	FX3
X15	1	QX3
X15	1	QX4
X15	1	QX4i
X15	1	N
X15	1	QX5
X15	1	N
X15	1	ZX6
X15	1	N
X86	1	GX1
X86	1	H3
X86	1	M
X86	1	H1
X86	1	G+
X86	1	M
X86	1	BSB

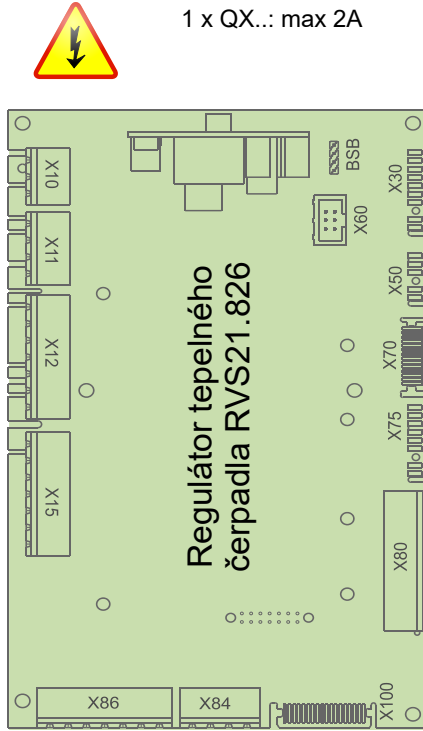

Total: max 6A
 1 x QX...: max 2A

BSB
X30
X60
X50
X70

- Pripojenie Servicetool (OCI700)
- Obslužná jednotka
- Modbus clip-in OCI351.01
- Rozširovací modul AVS75.xxx
- LPB clip-in

D1
D2
D3
UX3
M
DI6
DI7
M

- D1 Digitálny výstup 1 kúrenia
- D2 Digitálny výstup 2 chladenia
- D3 Digitálny výstup 3 TČ Zap./Vyp.

- DI6 Digitálny vstup 6 odmrazenie
- DI7 Digitálny vstup 7 Alarm

BX1
M
BX2
M
UX1
M
UX2
M

- B91 Snímač vstupu zdroja B91
- B84 Snímač výstupu zdroja B92/B84
- K19 Ventilátor K19
- 0..10V analógový signál
- Q9 Čerpadlo kondenzátora Q9
- PWM Signal

BX3
M
BX4
M

- B71 Snímač teploty spiatocky TČ B71
- B9 Snímač vonkajšej teploty B9

Hlavné napájanie 230V / 50 Hz
 Uzemnenie
 Nulový vodič

K10 Alarmový výstup K10

V81 EEV výparníka V81

X10	1	L
X10	1	PE
X10	1	N
X110	1	QX31
X110	1	QX32
X110	1	QX33
X110	1	N
X110	1	ZX34
X110	1	N
X115	1	QX35
X115	1	QX35i
X115	1	N

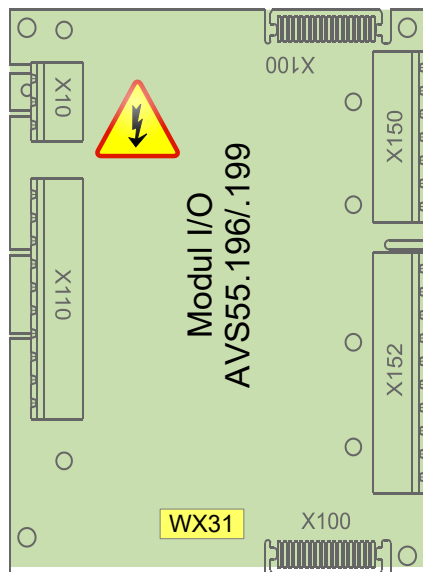

BSB
M
G+
H31
M
H32
GX1
H33
M
BX31
M
BX32
M
BX33
M
BX34
M

- 5V/12V aktívne snímače
- Meranie prietoku 10V
- Nízky tlak 0..10V
- 5V/12V aktívne snímače
- Vysoký tlak 0..10V
- B21 Snímač teploty výstupu TČ B21
- B81 Snímač horúcich plynov B81
- B85 Snímač plynov sania B85
- B83 Snímač chladiaceho média B83



- AVS75.390
- AVS75.391
- AVS75.370

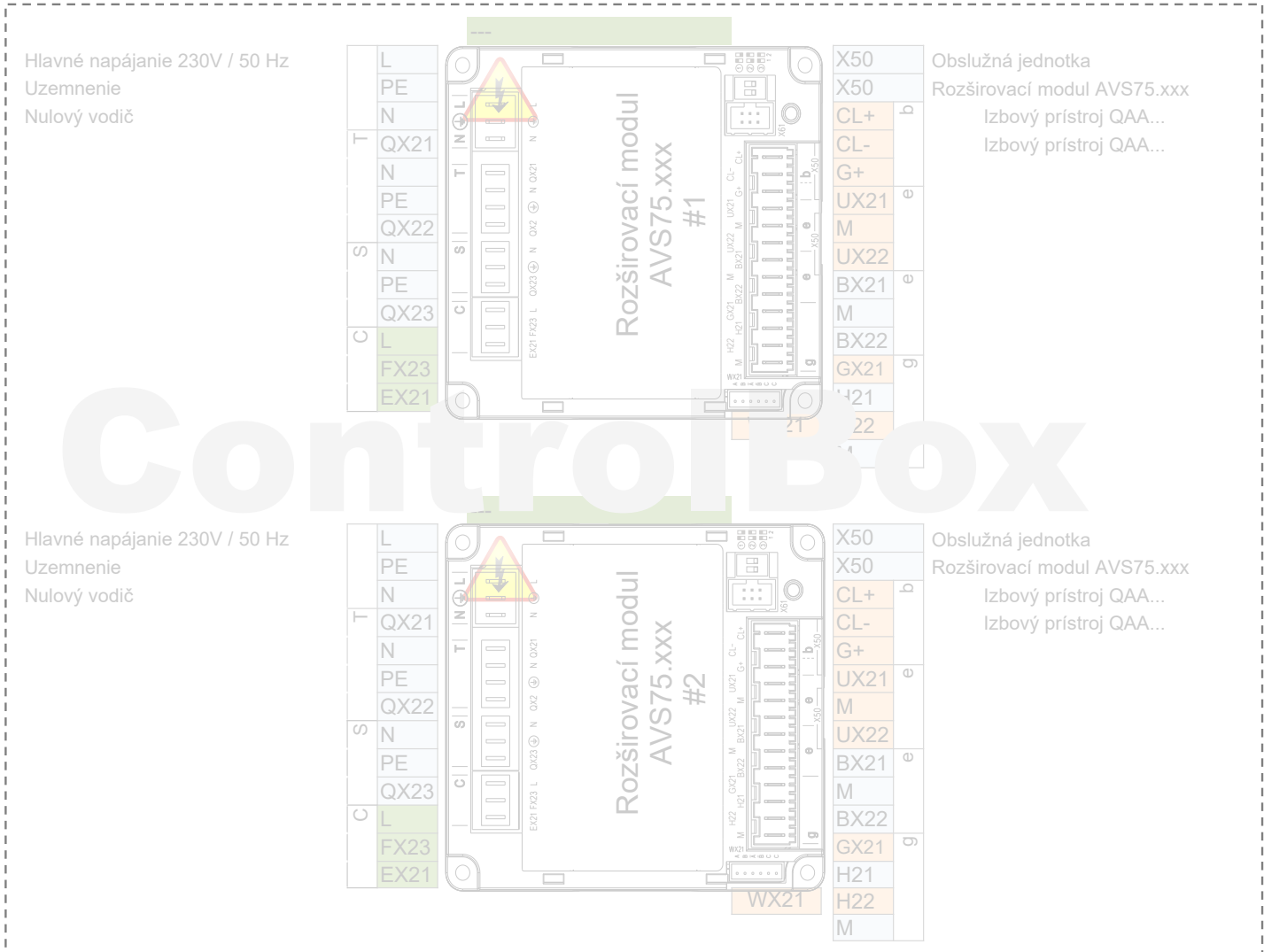

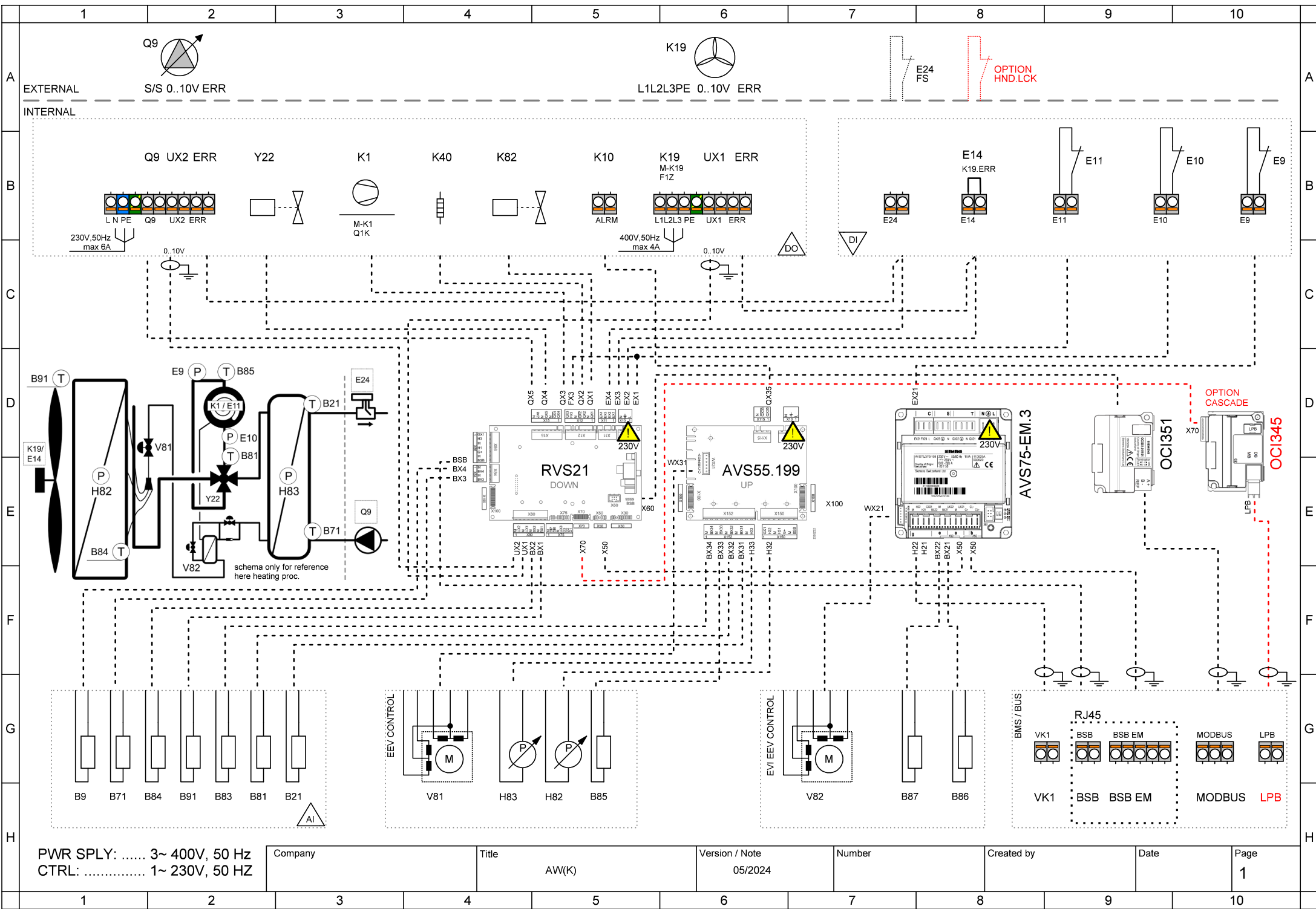

PWR SPLY: 3~ 400V, 50 Hz
 CTRL: 1~ 230V, 50 HZ

Company	Title	Version / Note	Number	Created by	Date	Page
	AW(K)	05/2024				1

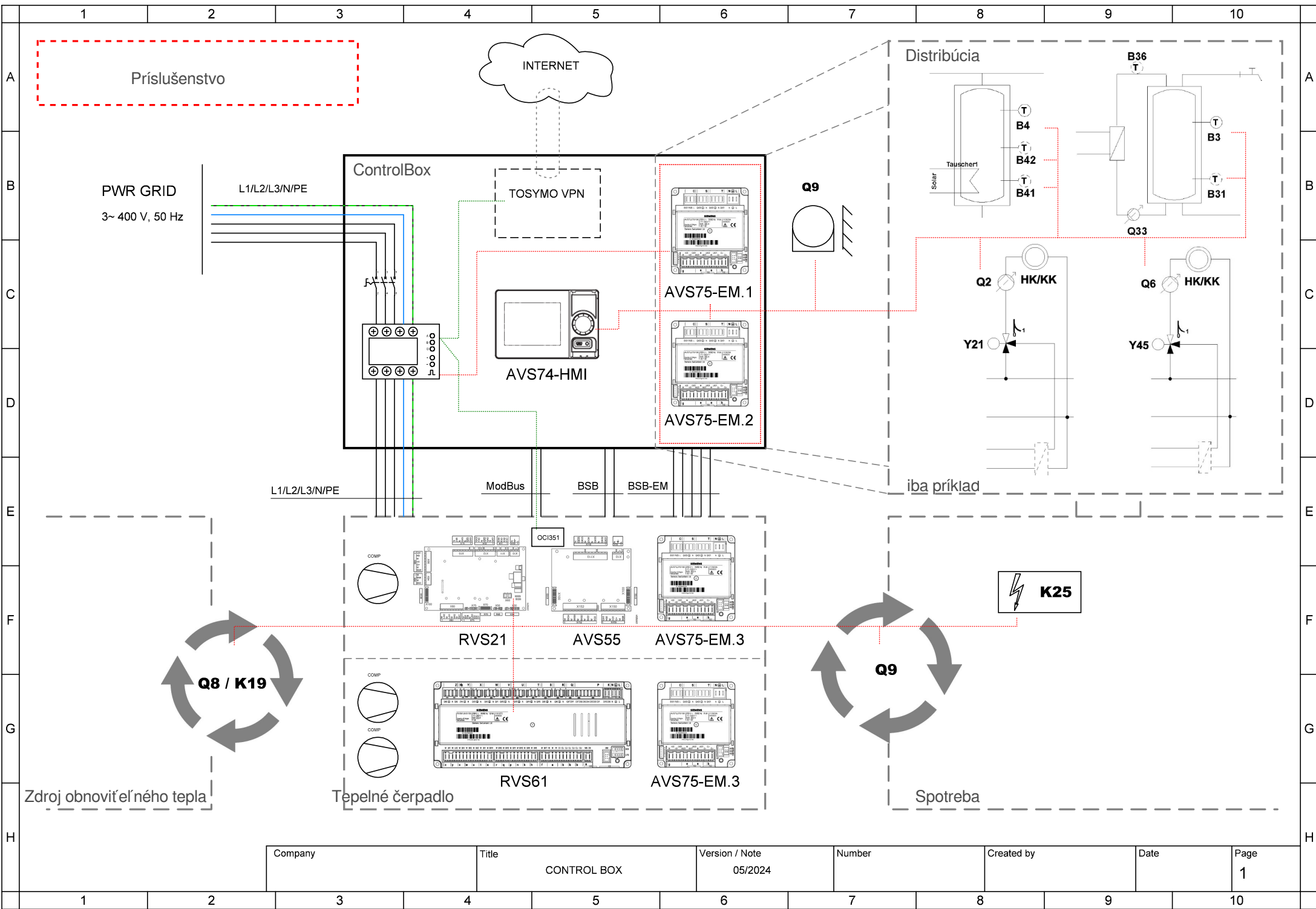

Company	Title	Version / Note	Number	Created by	Date	Page
	CONTROL BOX	05/2024				1



Company	Title	Version / Note	Number	Created by	Date	Page
	CONTROL BOX	05/2024				2



Company	Title	Version / Note	Number	Created by	Date	Page
	CONTROL BOX	05/2024				3



Company	Title	Version / Note	Number	Created by	Date	Page
	CONTROL BOX	05/2024				4



- AVS75.390
- AVS75.391
- AVS75.370

- AVS75.370**
 Hlavné napájanie 230V / 50 Hz
 Uzemnenie
 Nulový vodič
- Y1** Zmiešavací ventil otváranie
 - Y2** Zmiešavací ventil zatvárať
 - Q2** Čerpadlo vyk. okruhu 1 Q2
 - L** Fáza 230V
 - E61** Smart Grid E61

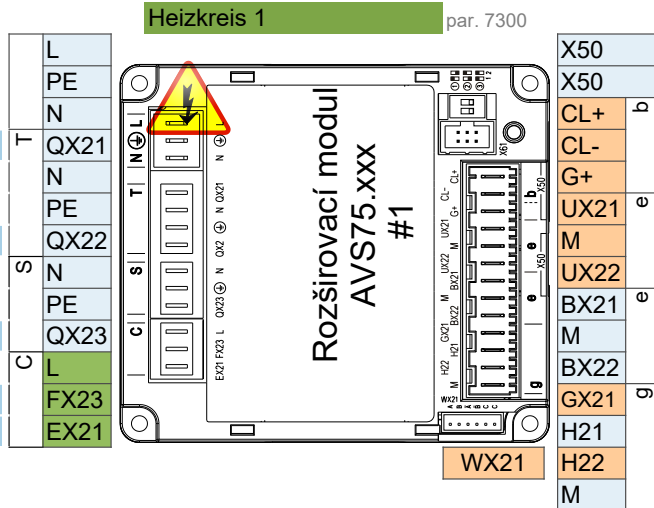

- Rozšiřovací modul AVS75.xxx
 Izbový prístroj QAA...
 Izbový prístroj QAA...

B1 Snímač prietoku 1

Čítanie pulzov

- AVS75.370**
 Hlavné napájanie 230V / 50 Hz
 Uzemnenie
 Nulový vodič
- Q3** Servopohon TUV Q3
 - K6** El. výhrevná vložka TUV K6
 - Q6** Čerpadlo vyk. okruhu 2 Q6
 - L** Fáza 230V
 - E62** Smart Grid E62

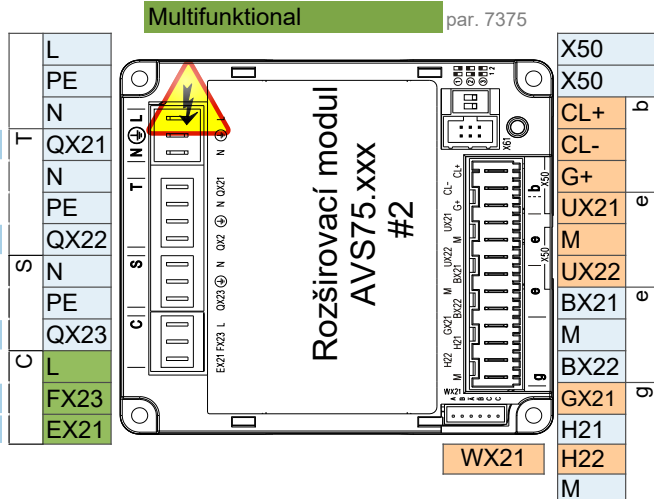

- Obslužná jednotka
 Rozšiřovací modul AVS75.xxx
 Izbový prístroj QAA...
 Izbový prístroj QAA...

B3 Snímač TUV B3

B4 Snímač AKU zásobníka B4

- Hlavné napájanie 230V / 50 Hz
 Uzemnenie
 Nulový vodič

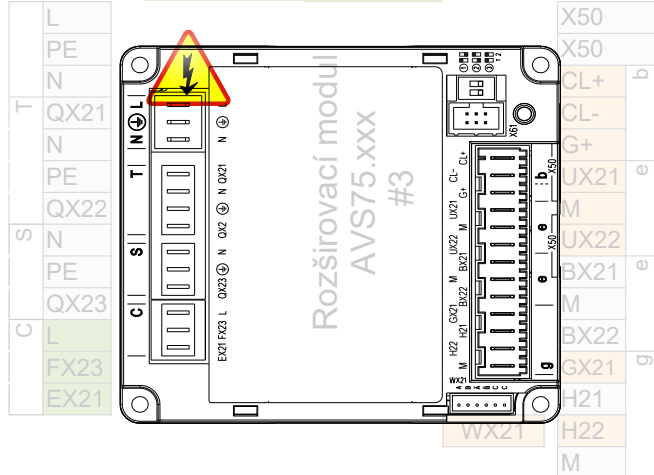

- Obslužná jednotka
 Rozšiřovací modul AVS75.xxx
 Izbový prístroj QAA...
 Izbový prístroj QAA...

Pozor: Rozšiřovací modul 3 je v tepelnom čerpadle

1 ControlBox

ControlBox s dvoma zabudovanými rozširujúcimi modulmi umožňuje početné možnosti ovládania aplikácie na strane spotrebiča za tepelným čerpadlom. Viac informácií nájdete v schéme ControlBoxu a v hárku s aplikačnými schémami.

2 Fixná žiadaná teplota výstupu - Zap / Vyp bezpotenciálny kontakt

2-vodičový tienený kábel 2 x 0,5 mm² - Nastavená hodnota = 45 °C (upraviteľné parametrom 1859)

Pripojovacia svorka - pozri schému zapojenia

3 Analógová regulácia žiadanej teploty výstupu 0..10V

2-vodičový tienený kábel 2 x 0,5 mm² - Nastavená hodnota: 0V = 16°C ~ 10V = 60°C (možnosť úpravy v nastavení parametrov)

Pripojovacia svorka - pozri schému zapojenia

4 ModBus RTU komunikačný príkaz

3 žilový tienený kábel min. 3 x 0,25 mm²

Pre tabuľku mapovania ModBus kontaktujte technickú podporu

5 MQTT IoT komunikačný protokol

Pre viac informácií kontaktujte technickú podporu