



Heat pump



TWW 120 EVI

HeavyDuty

2L1

WAMAK TWW 120 EVI HeavyDuty 2L1

Product description

High-efficiency heat pump consisting of multiple modules of separate heat pumps. Each module contains one short closed refrigerant circuit with a pair of quiet Scroll compressors and robust stainless steel plate heat exchangers. Applications range from heating, cooling and domestic hot water heating of office or multi-functional buildings to cascading applications in industrial applications.

Use for demanding industrial applications. By combining the most suitable performance and application variants of heat pump modules, it is possible to tailor-make the complete system required. Each module is refrigeration, hydraulically and electrically isolated with a separate controller. The connection of the modules is cascaded, whereby each single controller can take over the function of the cascade master.

As a primary source, thermal energy from underground water at a depth of between 12 and 30 metres is used. A submersible pump delivers the groundwater to the heat pump and, depending on the quality and chemical composition, the heat from the groundwater is extracted either directly in the heat pump or through a separating heat exchanger with an intermediate circuit and antifreeze. The heat pump then raises this temperature to a usable temperature for heating or hot water.

The EVI (Enhanced Vapour Injection) technology allows the heat pump to achieve higher header flow temperatures even at lower source temperatures. EVI also has a positive impact on the compressor lifespan and overall system stability because the discharge gas temperature from the compressor is lower.

The twin compressors give the system robustness and the ability to distribute the heat output according to the actual load.

Product features

- Scroll compressor
- EVI technology
- Asymmetric plate heat exchanger
- Multi-stage capacity control
- High pressure switch
- Low pressure sensor - analogue
- Flow sensor consumer - analogue - (with accessory)
- Outdoor temperature sensor - (with accessory)
- Buffer temperature sensor - (with accessory)
- Modbus connection
- Two level frame
- Sylomer pads under compressor unit
- Electronic expansion valve
- Two-stage capacity control
- Phase and rotation control
- High pressure sensor - analogue
- Flow switch consumer - on/off - (with accessory)
- Flow switch source - on/off - (with accessory)
- DHW temperature sensor - (with accessory)
- Cascade control
- Solid frame structure

Basic performance data - WAMAK TWW 120 EVI HeavyDuty 2L1

Heating - EN 14511		
Heating capacity [kW]	W10 / W35 (max)	123.9 (62.0 / 123.9)
	W10 / W35 (min)	62.0 (62.0 / 123.9)
	W10 / W34	124.0 (62.0 / 124.0)
Electrical power input [kW]	W10 / W35 (max)	21.7 (10.7 / 21.7)
	W10 / W35 (min)	10.7 (10.7 / 21.7)
	W10 / W34	21.3 (15.3 / 31.0)
Heating efficiency faktor [COP]	W10 / W35 (max)	5.71
	W10 / W35 (min)	5.79
	W10 / W34	5.83
Seasonal space heating energy efficiency - SCOP EN 14825		
Average Climate / Low Temperature [35 °C]	SCOP	6.46
	η [%]	258.6
	Label	A+++
	Qhe [kWh]	39549.2
	Pdesignh [kW]	123.9
	Tbivalent [°C]	-10
Cooling		
Cooling capacity - [kW]	A35 / W23-18	96.9
	A25 / W23-18	101.8
	A35 / W12-7	72.8
	A25 / W12-7	72.8
Seasonal space cooling energy efficiency - SEER EN 14825		
[W 23 / 18 °C]	SEER	5.14
	Qce [kWh]	10682.5
	η_c [%]	205.7
Sound EN 12102		
Acoustic power - Lw	dB(A)	65.6
Acoustic pressure - Lp	1 m dB(A)	57.6
	5 m dB(A)	43.6
	10 m dB(A)	37.6
Mechanical and operational information		
Compressor type (3~ 400/50)	SCROLL / 2 /	On/Off
Refrigerant	R410A (GWP - 2088)	11.5 kg
Operating limit temperatures heating - (min / max) [°C]		25 / 65
Operating limit temperatures source - (min / max) [°C]		-10 (7) / 30
Weight		620 kg

Main technical data - WAMAK TWW 120 EVI HeavyDuty 2L1

Enclosure type		HD2L1		Heat energy rejection side data			
Basic dimensions	Height [mm]	2000		Operating limit temperatures heating	MAX [°C]	65	
	Width [mm]	820			MIN [°C]	25	
	Length [mm]	1200		for more see operating limits diagram			
Weight [kg]	620		Condenser	Port size	VIC 2.1/2 "		
Colour	Gray			Type	BPHE		
Enclosure IP Class	IP20			Count	1		
Refrigeration cycle				Material	AISI 316		
Compressor	Type	Scroll		Maximal operating pressure - refrigerant [bar]			50
	Number of stages	2		Maximal operating pressure - Water [bar]			6
	On/Off			Testing pressure [bar]			70
	Power factor Cosφ	0.64		Heat transfer medium			Water
	Winding resistance	0.76 Ohm		Volume flow @ dT 5K (nom) - Water [m3/h]			10.64 ~ 21.28
Refrigerant		R410A		Internal pressure drop - Water [kPa]			20
	Volme	11.5 kg		Temperature difference	@ 35°C (nom)	5 K	
	GWP	2088			@ 55°C	8 K	
	Safety class	A1			@ 65°C	10 K	
Refrigeration oil type	POE RL32-3MAF		Renewable energy extraction side data				
	Oil volume	2 x 3.38 L		Operating limit temperatures source	MIN [°C]	-10 (7)	
Maximal pressure - refrigerant [bar]	50		for more see operating limits diagram				
	PED class	2		Evaporator	MAX [°C]	30	
EVI - vapour injection with economizer			Port size		VIC 2.1/2 "		
Electrical connection data			Type		BPHE		
Line voltage [#~ V/Hz]	3~ 400/50		Count	1			
Current	nominal [A]	46.70		Material	AISI 316		
	maximal [A]	74.80		Maximal operating pressure - refrigerant [bar]			29
	starting [A]	63.04		Heat transfer medium			Water
Softstart	-		Maximal operating pressure - Water [bar]			6	
Main safety	C80		Volume flow - Water [m3/h]			11.05 ~ 22.10	
Control System			Internal pressure drop - Water [kPa]			20	
Main controller	SIEMENS	RVS 61	Temperature difference - Water			4 K	
Extension module	AVS75.3xx	AVS75.3xx	AVS75.372				
Bus Clip-In		LPB OCI346	Modbus OCI352				
Online connection		Web server OZW672	ToSyMo				
Superheat controller			SEC61				

*** with accessory

WAMAK TWW 120 EVI HeavyDuty 2L1

ErP (EU) No 811/2013: Technical parameters for heat pump space heaters

Model	TWW 120 EVI HeavyDuty 2L1
Air-to-water heat pump	no
Brine-to-water heat pump	no
Water-to-water heat pump	yes
Low-temperature heat pump	no
Equipped with a supplementary heater	no
Heat pump combination heater	no
Temperature application	low (35°C - 30°C)
Climate conditions	average

Item	Symbol	Value	Unit	Item	Symbol	Value	Unit
Rated heat output at Tdesignh	Prated	123.9	kW	Seasonal space heating energy efficiency	η_s	258.6	%
Declared capacity for heating for part load at indoor temperature 20 °C and outdoor temperature Tj				Declared coefficient of performance or primary energy ratio for part load at indoor temperature 20 °C and outdoor temperature Tj			
Tj = -7 °C	Pdh	124.0	kW	Tj = -7 °C	COPd	5.83	-
Tj = +2 °C	Pdh	124.1	kW	Tj = +2 °C	COPd	6.4	-
Tj = +7 °C	Pdh	124.2	kW	Tj = +7 °C	COPd	6.9	-
Tj = +12 °C	Pdh	124.2	kW	Tj = +12 °C	COPd	7.3	-
Tj = bivalent temperature	Pdh	123.9	kW	Tj = bivalent temperature	COPd	5.7	-
Tj = operation limit temperature	Pdh	---	kW	Tj = operation limit temperature	COPd	---	-
Bivalent temperature	Tbiv	-10	°C	Tj = operation limit temperature	TOL	---	°C
Power consumption in modes other than active mode				Heating water operating limit temperature	WTOL	65	°C
Off mode	Poff	0.010	kW	Supplementary heater			
Thermostat-off mode	Pto	0.010	kW	Rated heat output	Psup	19.0	kW
Standby mode	Psb	0.010	kW	Type of energy input	electricity		
Crankcase heater mode	Pck	0.000	kW	For air-to-water heat pumps:			
Other items				Rated air flow rate, outdoors	-	---	m ³ /h
Capacity control	multi-stage			For water- or brine-to-water heat pumps: Rated brine or water flow rate, outdoor heat exchanger			
Sound power level							
indoors	Lwa	66	dB			11.05 ~ 22.10	m ³ /h
outdoors	Lwa	---	dB				
Annual energy consumption	Q _{HE}	39549.2	kWh				

Contact details: WAMAK, s.r.o., Orovnicna 252, 96652, Orovnicna, Slovakia, info@wamak.sk

WAMAK TWW 120 EVI HeavyDuty 2L1

ErP (EU) No 811/2013: Technical parameters for heat pump space heaters

Model	TWW 120 EVI HeavyDuty 2L1
Air-to-water heat pump	no
Brine-to-water heat pump	no
Water-to-water heat pump	yes
Low-temperature heat pump	no
Equipped with a supplementary heater	no
Heat pump combination heater	no
Temperature application	middle (55°C - 47°C)
Climate conditions	average

Item	Symbol	Value	Unit	Item	Symbol	Value	Unit
Rated heat output at Tdesignh	Prated	123.4	kW	Seasonal space heating energy efficiency	η_s	200.6	%
Declared capacity for heating for part load at indoor temperature 20 °C and outdoor temperature Tj				Declared coefficient of performance or primary energy ratio for part load at indoor temperature 20 °C and outdoor temperature Tj			
Tj = -7 °C	Pdh	124.6	kW	Tj = -7 °C	COPd	4.03	-
Tj = +2 °C	Pdh	125.1	kW	Tj = +2 °C	COPd	5.2	-
Tj = +7 °C	Pdh	125.4	kW	Tj = +7 °C	COPd	5.9	-
Tj = +12 °C	Pdh	125.6	kW	Tj = +12 °C	COPd	6.5	-
Tj = bivalent temperature	Pdh	123.4	kW	Tj = bivalent temperature	COPd	3.6	-
Tj = operation limit temperature	Pdh	---	kW	Tj = operation limit temperature	COPd	---	-
Bivalent temperature	Tbiv	-10	°C	Tj = operation limit temperature	TOL	---	°C
Power consumption in modes other than active mode				Heating water operating limit temperature	WTOL	65	°C
Off mode	Poff	0.010	kW	Supplementary heater			
Thermostat-off mode	Pto	0.010	kW	Rated heat output	Psup	19.0	kW
Standby mode	Psb	0.010	kW	Type of energy input	electricity		
Crankcase heater mode	Pck	0.000	kW	For air-to-water heat pumps:			
Other items				Rated air flow rate, outdoors	-	---	m ³ /h
Capacity control	multi-stage			For water- or brine-to-water heat pumps: Rated brine or water flow rate, outdoor heat exchanger			
Sound power level							
indoors	Lwa	66	dB			11.05 ~ 22.10	m ³ /h
outdoors	Lwa	---	dB				
Annual energy consumption	Q _{HE}	50777.1	kWh				

Contact details: WAMAK, s.r.o., Orovnicna 252, 96652, Orovnicna, Slovakia, info@wamak.sk



ENERG Y IIA
 енергия - ενεργεια IE IA



TWW 120 EVI
 HeavyDuty 2L1

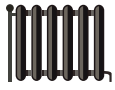

55 °C

35 °C



A+++

A+++



66 dB



--- dB

■ 130
 ■ 124
 ■ 121
 kW

■ 127
 ■ 124
 ■ 118
 kW



2019

811/2013

TWW 120 EVI
 HeavyDuty 2L1

ErP Data

	55 °C	35 °C
Energy class	A+++	A+++
η [%]	200.6	258.6
P_{rated} [kW]	124	124
Q_{HE} [kWh/y]	50778	39550
SCOP [-]	5.02	6.46
$T_{bivalent}$ [°C]	-10	-10

CONTROLLER



+ QAA55/75
 - QAA55/75

class VII
 class III

3.5% ↓
 1.5% ↓

Heating performance data

Version: v2024.010-BW-WW

Source - Brine [0°C] / Low Temperature [35°C]

ZHI46K1P-TWD_R410A_2_BWW

Operating conditions	Qh	P	COP
1 B0 / W30-35	98.4	21.7	4.53
2 B0 / W30-35 (MIN)	49.2	10.7	4.60
A B0 / Wxx-34	98.3	21.2	4.63
B B0 / Wxx-30	97.8	19.4	5.04
C B0 / Wxx-27	48.7	8.9	5.45
D B0 / Wxx-24	48.5	8.3	5.82
E B0 / Wxx-35	98.4	21.7	4.53
F B0 / Wxx-35	98.4	21.7	4.53

SCOP DATA EN 14825:2018	
Source - Brine [0°C] / Low Temperature [35°C]	
SCOPon	5.13
SCOPnet	5.13
SCOP	5.13
η [%]	205.17
Label	A+++
Qh [kWh]	39589
Pdesignh [kW]	98.4
Tbivalent [°C]	-10

Source - Brine [0°C] / Medium Temperature [55°C]

Operating conditions	Qh	P	COP
1 B0 / W47-55	100.4	34.0	2.95
2 B0 / W47-55 (MIN)	50.2	16.6	2.99
A B0 / Wxx-52	101.1	31.1	3.36
B B0 / Wxx-42	101.2	24.2	4.22
C B0 / Wxx-36	49.8	10.6	4.70
D B0 / Wxx-30	49.5	9.6	5.17
E B0 / Wxx-55	100.4	34.0	2.95
F B0 / Wxx-54	101.2	31.8	3.18

SCOP DATA EN 14825:2018	
Source - Brine [0°C] / Medium Temperature [55°C]	
SCOPon	4.11
SCOPnet	4.11
SCOP	4.10
η [%]	164.18
Label	A+++
Qh [kWh]	50489
Pdesignh [kW]	100.4
Tbivalent [°C]	-10

Source - Water [10°C] / Low Temperature [35°C]

Operating conditions	Qh	P	COP
1 W10 / W30-35	123.9	21.7	5.71
2 W10 / W30-35 (MIN)	62.0	10.7	5.79
A W10 / Wxx-34	124.0	21.3	5.83
B W10 / Wxx-30	124.1	19.5	6.35
C W10 / Wxx-27	124.2	18.3	6.86
D W10 / Wxx-24	124.2	17.2	7.32
E W10 / Wxx-35	123.9	21.7	5.71
F W10 / Wxx-35	123.9	21.7	5.71

SCOP DATA EN 14825:2018	
Source - Water [10°C] / Low Temperature [35°C]	
SCOPon	6.47
SCOPnet	6.47
SCOP	6.46
η [%]	258.60
Label	A+++
Qh [kWh]	39549
Pdesignh [kW]	123.9
Tbivalent [°C]	-10.00

WAMAK TWW 120 EVI HeavyDuty 2L1

Source - Water [10°C] / Medium Temperature [55°C]

	Operating conditions	Qh	P	COP
1	W10 / W47-55	123.4	34.0	3.63
2	W10 / W47-55 (MIN)	61.7	16.8	3.68
A	W10 / Wxx-52	124.6	31.0	4.03
B	W10 / Wxx-42	125.1	24.2	5.17
C	W10 / Wxx-36	125.4	21.5	5.92
D	W10 / Wxx-30	125.6	19.5	6.51
E	W10 / Wxx-55	123.4	34.0	3.63
F	W10 / Wxx-55	123.4	34.0	3.63

SCOP DATA EN 14825:2018	
Source - Water [10°C] / Medium Temperature [55°C]	
SCOPon	5.02
SCOPnet	5.02
SCOP	5.02
η [%]	200.64
Label	A+++
Qh [kWh]	50777
Pdesignh [kW]	123.4
Tbivalent [°C]	-10.00

Low temperature cooling W 12 / 7°C

	Operating conditions	Qc	P	EER
A	W30-35 / W12-7	74.8	23.2	3.22
B	W26-xx / W12-7	76.2	21.2	3.59
C	W22-xx / W12-7	77.3	19.4	3.98
D	W18-xx / W12-7	77.9	18.6	4.20

SEER DATA EN 14825:2018 [W 12 / 7°C]	
SEERon	3.86
SEER	3.86
Qc [kWh]	43680
η [%]	154.44

Radiant cooling W 23 / 18°C

	Operating conditions	Qc	P	EER
A	W50-xx / W23-18	86.9	36.5	2.38
B	W40-xx / W23-18	93.9	29.0	3.24
C	W30-35 / W23-18	99.5	23.2	4.29
D	W26-xx / W23-18	101.4	21.2	4.77

SEER DATA EN 14825:2018 [W 23 / 18°C]	
SEERon	5.15
SEER	5.14
Qc [kWh]	43680
η [%]	205.69

Performance lines - heating

- Qh-nom-35 - - - Qh-min-35 - - - - Qh-max-65 — Qh-nom-45 — Qh-nom-55
- Qh-nom-65

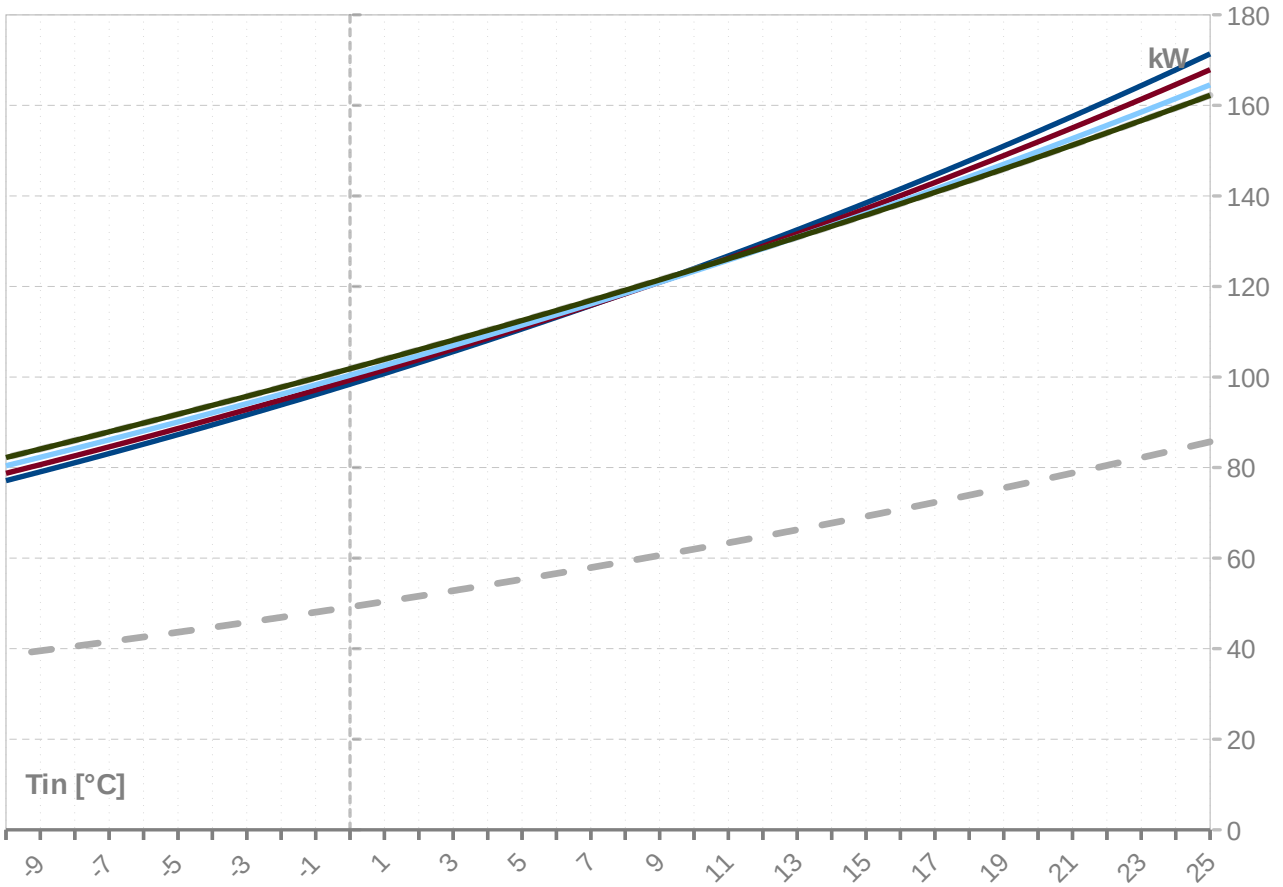

Performance lines - cooling

- Qc-nom-12-7 — Qc-nom-23-18

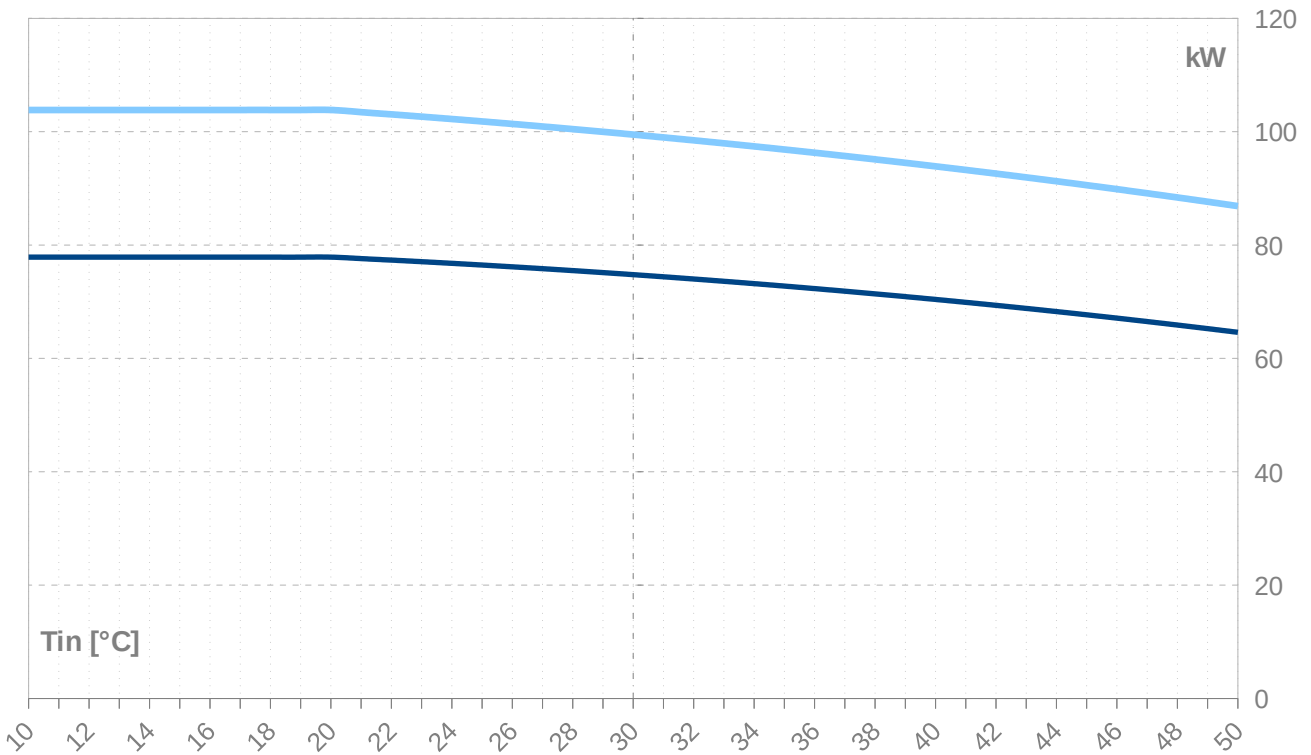

WAMAK TWW 120 EVI HeavyDuty 2L1

Th -OU	35										
Ts -IN [°C]	Qh nom [kW]	Qh min [kW]	Qh max [kW]	Pin nom [kW]	Pin min [kW]	Pin max [kW]	COP nom kW / kW	Qc nom [kW]	Qc min [kW]	Qc max [kW]	I nom [A]
25	171.4	85.7	171.4	22.2	10.9	22.2	7.73	150.7	75.3	150.7	46.9
24	167.8	83.9	167.8	22.1	10.9	22.1	7.59	147.2	73.6	147.2	46.8
23	164.4	82.2	164.4	22.1	10.9	22.1	7.45	143.8	71.9	143.8	46.7
22	160.9	80.5	160.9	22.0	10.9	22.0	7.31	140.4	70.2	140.4	46.6
21	157.6	78.8	157.6	22.0	10.8	22.0	7.18	137.1	68.5	137.1	46.6
20	154.3	77.1	154.3	21.9	10.8	21.9	7.04	133.8	66.9	133.8	46.5
19	151.0	75.5	151.0	21.9	10.8	21.9	6.90	130.6	65.3	130.6	46.5
18	147.8	73.9	147.8	21.8	10.8	21.8	6.76	127.4	63.7	127.4	46.5
17	144.6	72.3	144.6	21.8	10.8	21.8	6.63	124.3	62.1	124.3	46.5
16	141.5	70.8	141.5	21.8	10.7	21.8	6.49	121.2	60.6	121.2	46.5
15	138.5	69.2	138.5	21.8	10.7	21.8	6.36	118.1	59.1	118.1	46.5
14	135.5	67.7	135.5	21.8	10.7	21.8	6.23	115.1	57.6	115.1	46.5
13	132.5	66.3	132.5	21.7	10.7	21.7	6.10	112.2	56.1	112.2	46.5
12	129.6	64.8	129.6	21.7	10.7	21.7	5.96	109.3	54.7	109.3	46.5
11	126.8	63.4	126.8	21.7	10.7	21.7	5.84	106.5	53.2	106.5	46.6
10	123.9	62.0	123.9	21.7	10.7	21.7	5.71	103.7	51.8	103.7	46.6
9	121.2	60.6	121.2	21.7	10.7	21.7	5.58	100.9	50.5	100.9	46.6
8	118.5	59.2	118.5	21.7	10.7	21.7	5.46	98.2	49.1	98.2	46.7
7	115.8	57.9	115.8	21.7	10.7	21.7	5.34	95.5	47.8	95.5	46.7
6	113.2	56.6	113.2	21.7	10.7	21.7	5.22	92.9	46.5	92.9	46.8
5	110.6	55.3	110.6	21.7	10.7	21.7	5.10	90.4	45.2	90.4	46.9
4	108.1	54.0	108.1	21.7	10.7	21.7	4.98	87.8	43.9	87.8	46.9
3	105.6	52.8	105.6	21.7	10.7	21.7	4.87	85.3	42.7	85.3	47.0
2	103.2	51.6	103.2	21.7	10.7	21.7	4.75	82.9	41.4	82.9	47.0
1	100.8	50.4	100.8	21.7	10.7	21.7	4.64	80.5	40.3	80.5	47.1
0	98.4	49.2	98.4	21.7	10.7	21.7	4.53	78.1	39.1	78.1	47.1
-1	96.1	48.1	96.1	21.7	10.7	21.7	4.43	75.8	37.9	75.8	47.2
-2	93.8	46.9	93.8	21.7	10.7	21.7	4.32	73.6	36.8	73.6	47.3
-3	91.6	45.8	91.6	21.7	10.7	21.7	4.22	71.3	35.7	71.3	47.3
-4	89.4	44.7	89.4	21.7	10.7	21.7	4.12	69.2	34.6	69.2	47.3
-5	87.3	43.6	87.3	21.7	10.7	21.7	4.02	67.0	33.5	67.0	47.4
-6	85.2	42.6	85.2	21.7	10.7	21.7	3.93	64.9	32.5	64.9	47.4
-7	83.1	41.5	83.1	21.7	10.7	21.7	3.83	62.8	31.4	62.8	47.5
-8	81.1	40.5	81.1	21.7	10.7	21.7	3.74	60.8	30.4	60.8	47.5
-9	79.1	39.5	79.1	21.7	10.7	21.7	3.65	58.8	29.4	58.8	47.5
-10	77.1	38.6	77.1	21.6	10.7	21.6	3.56	56.9	28.4	56.9	47.5
-11	75.2	37.6	75.2	21.6	10.7	21.6	3.48	55.0	27.5	55.0	47.5
-12	73.3	36.6	73.3	21.6	10.6	21.6	3.39	53.1	26.6	53.1	47.5
-13	71.4	35.7	71.4	21.6	10.6	21.6	3.31	51.3	25.7	51.3	47.5
-14	69.6	34.8	69.6	21.5	10.6	21.5	3.23	49.5	24.8	49.5	47.4
-15	67.8	33.9	67.8	21.5	10.6	21.5	3.16	47.8	23.9	47.8	47.4

-- attention: operating limits not reflected in performance table

ZHI46K1P-TWD_R410A_2_BWW

WAMAK TWW 120 EVI HeavyDuty 2L1

Th -OU	45										
[°C]	Qh nom [kW]	Qh min [kW]	Qh max [kW]	Pin nom [kW]	Pin min [kW]	Pin max [kW]	COP nom kW / kW	Qc nom [kW]	Qc min [kW]	Qc max [kW]	I nom [A]
25	167.9	83.9	167.9	26.7	13.1	26.7	6.30	143.0	71.5	143.0	52.9
24	164.6	82.3	164.6	26.6	13.1	26.6	6.18	139.7	69.9	139.7	52.9
23	161.4	80.7	161.4	26.6	13.1	26.6	6.06	136.5	68.2	136.5	52.8
22	158.2	79.1	158.2	26.6	13.1	26.6	5.94	133.3	66.7	133.3	52.8
21	155.0	77.5	155.0	26.6	13.1	26.6	5.82	130.2	65.1	130.2	52.7
20	151.9	76.0	151.9	26.6	13.1	26.6	5.71	127.1	63.5	127.1	52.7
19	148.9	74.4	148.9	26.6	13.1	26.6	5.59	124.0	62.0	124.0	52.7
18	145.9	73.0	145.9	26.6	13.1	26.6	5.48	121.0	60.5	121.0	52.7
17	143.0	71.5	143.0	26.6	13.1	26.6	5.37	118.1	59.0	118.1	52.7
16	140.0	70.0	140.0	26.6	13.1	26.6	5.26	115.2	57.6	115.2	52.7
15	137.2	68.6	137.2	26.6	13.1	26.6	5.15	112.3	56.2	112.3	52.7
14	134.4	67.2	134.4	26.7	13.1	26.7	5.04	109.5	54.7	109.5	52.7
13	131.6	65.8	131.6	26.7	13.2	26.7	4.94	106.7	53.4	106.7	52.7
12	128.9	64.4	128.9	26.7	13.2	26.7	4.83	104.0	52.0	104.0	52.7
11	126.2	63.1	126.2	26.7	13.2	26.7	4.73	101.3	50.6	101.3	52.8
10	123.6	61.8	123.6	26.7	13.2	26.7	4.63	98.6	49.3	98.6	52.8
9	121.0	60.5	121.0	26.7	13.2	26.7	4.53	96.0	48.0	96.0	52.8
8	118.4	59.2	118.4	26.7	13.2	26.7	4.43	93.4	46.7	93.4	52.8
7	115.9	57.9	115.9	26.7	13.2	26.7	4.33	90.9	45.4	90.9	52.8
6	113.4	56.7	113.4	26.8	13.2	26.8	4.24	88.4	44.2	88.4	52.9
5	111.0	55.5	111.0	26.8	13.2	26.8	4.14	86.0	43.0	86.0	52.9
4	108.6	54.3	108.6	26.8	13.2	26.8	4.05	83.5	41.8	83.5	52.9
3	106.2	53.1	106.2	26.8	13.2	26.8	3.96	81.2	40.6	81.2	52.9
2	103.9	51.9	103.9	26.8	13.2	26.8	3.88	78.8	39.4	78.8	52.9
1	101.6	50.8	101.6	26.8	13.2	26.8	3.79	76.6	38.3	76.6	53.0
0	99.3	49.7	99.3	26.8	13.2	26.8	3.71	74.3	37.2	74.3	53.0
-1	97.1	48.6	97.1	26.8	13.2	26.8	3.62	72.1	36.0	72.1	53.0
-2	94.9	47.5	94.9	26.8	13.2	26.8	3.54	69.9	35.0	69.9	53.0
-3	92.8	46.4	92.8	26.8	13.2	26.8	3.46	67.8	33.9	67.8	52.9
-4	90.7	45.3	90.7	26.8	13.2	26.8	3.39	65.7	32.8	65.7	52.9
-5	88.6	44.3	88.6	26.8	13.2	26.8	3.31	63.6	31.8	63.6	52.9
-6	86.6	43.3	86.6	26.8	13.2	26.8	3.24	61.6	30.8	61.6	52.9
-7	84.6	42.3	84.6	26.7	13.2	26.7	3.16	59.6	29.8	59.6	52.8
-8	82.6	41.3	82.6	26.7	13.2	26.7	3.09	57.6	28.8	57.6	52.8
-9	80.6	40.3	80.6	26.7	13.2	26.7	3.02	55.7	27.9	55.7	52.7
-10	78.7	39.4	78.7	26.6	13.1	26.6	2.96	53.8	26.9	53.8	52.6
-11	76.8	38.4	76.8	26.6	13.1	26.6	2.89	52.0	26.0	52.0	52.5
-12	75.0	37.5	75.0	26.5	13.1	26.5	2.82	50.2	25.1	50.2	52.4
-13	73.2	36.6	73.2	26.5	13.1	26.5	2.76	48.4	24.2	48.4	52.3
-14	71.4	35.7	71.4	26.4	13.0	26.4	2.70	46.7	23.3	46.7	52.2
-15	69.6	34.8	69.6	26.4	13.0	26.4	2.64	45.0	22.5	45.0	52.0

-- attention: operating limits not reflected in performance table

WAMAK TWW 120 EVI HeavyDuty 2L1

Th -OU		55										
Ts -IN	Qh nom	Qh min	Qh max	Pin nom	Pin min	Pin max	COP nom	Qc nom	Qc min	Qc max	I nom	
[°C]	[kW]	[kW]	[kW]	[kW]	[kW]	[kW]	kW / kW	[kW]	[kW]	[kW]	[A]	
25	164.5	82.3	164.5	33.7	16.6	33.7	4.89	133.1	66.5	133.1	61.3	
24	161.5	80.8	161.5	33.7	16.6	33.7	4.79	130.0	65.0	130.0	61.3	
23	158.5	79.3	158.5	33.7	16.6	33.7	4.70	127.0	63.5	127.0	61.3	
22	155.6	77.8	155.6	33.7	16.6	33.7	4.61	124.1	62.0	124.1	61.3	
21	152.7	76.3	152.7	33.8	16.6	33.8	4.52	121.2	60.6	121.2	61.3	
20	149.8	74.9	149.8	33.8	16.7	33.8	4.44	118.3	59.1	118.3	61.3	
19	147.0	73.5	147.0	33.8	16.7	33.8	4.35	115.4	57.7	115.4	61.3	
18	144.2	72.1	144.2	33.8	16.7	33.8	4.26	112.6	56.3	112.6	61.3	
17	141.5	70.7	141.5	33.9	16.7	33.9	4.18	109.9	54.9	109.9	61.3	
16	138.8	69.4	138.8	33.9	16.7	33.9	4.10	107.1	53.6	107.1	61.4	
15	136.1	68.1	136.1	33.9	16.7	33.9	4.01	104.4	52.2	104.4	61.4	
14	133.5	66.7	133.5	33.9	16.7	33.9	3.93	101.8	50.9	101.8	61.4	
13	130.9	65.4	130.9	34.0	16.7	34.0	3.86	99.2	49.6	99.2	61.4	
12	128.3	64.2	128.3	34.0	16.8	34.0	3.78	96.6	48.3	96.6	61.5	
11	125.8	62.9	125.8	34.0	16.8	34.0	3.70	94.1	47.0	94.1	61.5	
10	123.4	61.7	123.4	34.0	16.8	34.0	3.63	91.6	45.8	91.6	61.5	
9	120.9	60.5	120.9	34.0	16.8	34.0	3.55	89.1	44.6	89.1	61.5	
8	118.5	59.3	118.5	34.0	16.8	34.0	3.48	86.7	43.4	86.7	61.5	
7	116.1	58.1	116.1	34.1	16.8	34.1	3.41	84.3	42.2	84.3	61.5	
6	113.8	56.9	113.8	34.1	16.8	34.1	3.34	82.0	41.0	82.0	61.5	
5	111.5	55.7	111.5	34.1	16.8	34.1	3.27	79.7	39.8	79.7	61.5	
4	109.2	54.6	109.2	34.1	16.8	34.1	3.20	77.4	38.7	77.4	61.5	
3	107.0	53.5	107.0	34.1	16.8	34.1	3.14	75.1	37.6	75.1	61.5	
2	104.7	52.4	104.7	34.1	16.8	34.1	3.07	72.9	36.5	72.9	61.5	
1	102.6	51.3	102.6	34.1	16.8	34.1	3.01	70.8	35.4	70.8	61.5	
0	100.4	50.2	100.4	34.0	16.8	34.0	2.95	68.6	34.3	68.6	61.4	
-1	98.3	49.1	98.3	34.0	16.8	34.0	2.89	66.5	33.3	66.5	61.4	
-2	96.2	48.1	96.2	34.0	16.8	34.0	2.83	64.4	32.2	64.4	61.3	
-3	94.1	47.1	94.1	34.0	16.8	34.0	2.77	62.4	31.2	62.4	61.3	
-4	92.1	46.0	92.1	33.9	16.7	33.9	2.71	60.4	30.2	60.4	61.2	
-5	90.1	45.0	90.1	33.9	16.7	33.9	2.66	58.4	29.2	58.4	61.1	
-6	88.1	44.0	88.1	33.9	16.7	33.9	2.60	56.5	28.2	56.5	61.0	
-7	86.1	43.1	86.1	33.8	16.7	33.8	2.55	54.6	27.3	54.6	60.9	
-8	84.2	42.1	84.2	33.7	16.6	33.7	2.50	52.7	26.3	52.7	60.8	
-9	82.3	41.1	82.3	33.7	16.6	33.7	2.44	50.8	25.4	50.8	60.6	
-10	80.4	40.2	80.4	33.6	16.6	33.6	2.39	49.0	24.5	49.0	60.5	
-11	78.5	39.3	78.5	33.5	16.5	33.5	2.34	47.2	23.6	47.2	60.3	
-12	76.7	38.3	76.7	33.4	16.5	33.4	2.29	45.5	22.7	45.5	60.1	
-13	74.9	37.4	74.9	33.3	16.4	33.3	2.25	43.7	21.9	43.7	59.9	
-14	73.1	36.5	73.1	33.2	16.4	33.2	2.20	42.1	21.0	42.1	59.7	
-15	71.3	35.7	71.3	33.1	16.3	33.1	2.15	40.4	20.2	40.4	59.4	

-- attention: operating limits not reflected in performance table

WAMAK TWW 120 EVI HeavyDuty 2L1

Th -OU	65 (T-max)										
[°C]	Qh nom [kW]	Qh min [kW]	Qh max [kW]	Pin nom [kW]	Pin min [kW]	Pin max [kW]	COP nom kW / kW	Qc nom [kW]	Qc min [kW]	Qc max [kW]	I nom [A]
25	162.2	81.1	162.2	42.9	21.2	42.9	3.78	122.2	61.1	122.2	71.9
24	159.4	79.7	159.4	42.9	21.2	42.9	3.71	119.3	59.7	119.3	72.0
23	156.6	78.3	156.6	43.0	21.2	43.0	3.65	116.5	58.3	116.5	72.0
22	153.9	77.0	153.9	43.0	21.2	43.0	3.58	113.8	56.9	113.8	72.1
21	151.2	75.6	151.2	43.0	21.2	43.0	3.51	111.0	55.5	111.0	72.2
20	148.6	74.3	148.6	43.1	21.2	43.1	3.45	108.3	54.2	108.3	72.2
19	145.9	73.0	145.9	43.1	21.3	43.1	3.39	105.7	52.8	105.7	72.3
18	143.3	71.7	143.3	43.1	21.3	43.1	3.32	103.1	51.5	103.1	72.3
17	140.8	70.4	140.8	43.2	21.3	43.2	3.26	100.5	50.2	100.5	72.4
16	138.3	69.1	138.3	43.2	21.3	43.2	3.20	97.9	49.0	97.9	72.4
15	135.8	67.9	135.8	43.2	21.3	43.2	3.14	95.4	47.7	95.4	72.5
14	133.3	66.7	133.3	43.2	21.3	43.2	3.08	92.9	46.5	92.9	72.6
13	130.9	65.4	130.9	43.2	21.3	43.2	3.03	90.5	45.3	90.5	72.6
12	128.5	64.2	128.5	43.3	21.3	43.3	2.97	88.1	44.0	88.1	72.6
11	126.1	63.1	126.1	43.3	21.3	43.3	2.92	85.7	42.9	85.7	72.7
10	123.8	61.9	123.8	43.3	21.3	43.3	2.86	83.4	41.7	83.4	72.7
9	121.5	60.7	121.5	43.3	21.3	43.3	2.81	81.0	40.5	81.0	72.7
8	119.2	59.6	119.2	43.3	21.3	43.3	2.75	78.8	39.4	78.8	72.8
7	116.9	58.5	116.9	43.3	21.3	43.3	2.70	76.5	38.3	76.5	72.8
6	114.7	57.3	114.7	43.2	21.3	43.2	2.65	74.3	37.1	74.3	72.8
5	112.5	56.2	112.5	43.2	21.3	43.2	2.60	72.1	36.1	72.1	72.8
4	110.3	55.2	110.3	43.2	21.3	43.2	2.55	70.0	35.0	70.0	72.8
3	108.1	54.1	108.1	43.2	21.3	43.2	2.50	67.8	33.9	67.8	72.7
2	106.0	53.0	106.0	43.1	21.3	43.1	2.46	65.7	32.9	65.7	72.7
1	103.9	52.0	103.9	43.1	21.3	43.1	2.41	63.7	31.8	63.7	72.6
0	101.8	50.9	101.8	43.1	21.2	43.1	2.37	61.6	30.8	61.6	72.6
-1	99.8	49.9	99.8	43.0	21.2	43.0	2.32	59.6	29.8	59.6	72.5
-2	97.7	48.9	97.7	42.9	21.2	42.9	2.28	57.6	28.8	57.6	72.4
-3	95.7	47.9	95.7	42.9	21.1	42.9	2.23	55.7	27.8	55.7	72.3
-4	93.7	46.9	93.7	42.8	21.1	42.8	2.19	53.8	26.9	53.8	72.2
-5	91.8	45.9	91.8	42.7	21.1	42.7	2.15	51.9	25.9	51.9	72.1
-6	89.8	44.9	89.8	42.6	21.0	42.6	2.11	50.0	25.0	50.0	71.9
-7	87.9	43.9	87.9	42.5	21.0	42.5	2.07	48.2	24.1	48.2	71.8
-8	86.0	43.0	86.0	42.4	20.9	42.4	2.03	46.4	23.2	46.4	71.6
-9	84.1	42.0	84.1	42.3	20.9	42.3	1.99	44.6	22.3	44.6	71.4
-10	82.2	41.1	82.2	42.2	20.8	42.2	1.95	42.8	21.4	42.8	71.2
-11	80.4	40.2	80.4	42.0	20.7	42.0	1.91	41.1	20.5	41.1	70.9
-12	78.5	39.3	78.5	41.9	20.7	41.9	1.87	39.4	19.7	39.4	70.6
-13	76.7	38.3	76.7	41.7	20.6	41.7	1.84	37.7	18.9	37.7	70.4
-14	74.9	37.4	74.9	41.6	20.5	41.6	1.80	36.1	18.0	36.1	70.1
-15	73.1	36.5	73.1	41.4	20.4	41.4	1.77	34.4	17.2	34.4	69.7

-- attention: operating limits not reflected in performance table

WAMAK TWW 120 EVI HeavyDuty 2L1

Tc -OU		W 12 / 7 °C									
Ts -IN	Qc nom	Qc min	Qc max	Pin nom	Pin min	Pin max	EER	Qh nom	Qh min	Qh max	I nom
[°C]	[kW]	[kW]	[kW]	[kW]	[kW]	[kW]	kW / kW	[kW]	[kW]	[kW]	[A]
40	70.4	35.2	70.4	29.0	14.3	29.0	2.43	97.5	48.7	97.5	55.5
39	70.9	35.5	70.9	28.4	14.0	28.4	2.50	97.4	48.7	97.4	54.7
38	71.4	35.7	71.4	27.7	13.7	27.7	2.58	97.3	48.6	97.3	54.0
37	71.9	35.9	71.9	27.1	13.4	27.1	2.65	97.2	48.6	97.2	53.3
36	72.3	36.2	72.3	26.5	13.1	26.5	2.73	97.1	48.5	97.1	52.6
35	72.8	36.4	72.8	25.9	12.8	25.9	2.81	97.0	48.5	97.0	52.0
34	73.2	36.6	73.2	25.4	12.5	25.4	2.89	96.9	48.4	96.9	51.3
33	73.6	36.8	73.6	24.8	12.2	24.8	2.97	96.8	48.4	96.8	50.7
32	74.0	37.0	74.0	24.3	12.0	24.3	3.05	96.7	48.3	96.7	50.1
31	74.4	37.2	74.4	23.7	11.7	23.7	3.14	96.6	48.3	96.6	49.5
30	74.8	37.4	74.8	23.2	11.4	23.2	3.22	96.4	48.2	96.4	48.9
29	75.1	37.6	75.1	22.7	11.2	22.7	3.31	96.3	48.2	96.3	48.3
28	75.5	37.7	75.5	22.2	10.9	22.2	3.40	96.2	48.1	96.2	47.7
27	75.8	37.9	75.8	21.7	10.7	21.7	3.49	96.1	48.1	96.1	47.2
26	76.2	38.1	76.2	21.2	10.5	21.2	3.59	96.0	48.0	96.0	46.7
25	76.5	38.2	76.5	20.8	10.2	20.8	3.68	95.9	47.9	95.9	46.1
24	76.8	38.4	76.8	20.3	10.0	20.3	3.78	95.7	47.9	95.7	45.6
23	77.1	38.5	77.1	19.9	9.8	19.9	3.88	95.6	47.8	95.6	45.1
22	77.3	38.7	77.3	19.4	9.6	19.4	3.98	95.5	47.7	95.5	44.6
21	77.6	38.8	77.6	19.0	9.4	19.0	4.09	95.3	47.7	95.3	44.1
20	77.9	38.9	77.9	18.6	9.1	18.6	4.20	95.2	47.6	95.2	43.6

Tc [°C]		W 23 / 18 °C									
0	Qc nom	Qc min	Qc max	Pin nom	Pin min	Pin max	EER	Qh nom	Qh min	Qh max	I nom
[°C]	[kW]	[kW]	[kW]	[kW]	[kW]	[kW]	kW / kW	[kW]	[kW]	[kW]	[A]
40	93.9	46.9	93.9	29.0	14.3	29.0	3.24	120.9	60.4	121.0	55.4
39	94.5	47.3	94.5	28.4	14.0	28.4	3.33	120.9	60.5	121.0	54.7
38	95.1	47.6	95.1	27.7	13.7	27.7	3.43	120.9	60.5	120.9	53.9
37	95.7	47.9	95.7	27.1	13.4	27.1	3.53	120.9	60.5	120.9	53.2
36	96.3	48.1	96.3	26.5	13.1	26.5	3.63	121.0	60.5	120.9	52.4
35	96.9	48.4	96.9	25.9	12.8	25.9	3.74	121.0	60.5	120.9	51.7
34	97.4	48.7	97.4	25.4	12.5	25.4	3.84	121.0	60.5	120.9	51.1
33	97.9	49.0	97.9	24.8	12.2	24.8	3.95	121.0	60.5	120.9	50.4
32	98.5	49.2	98.5	24.3	12.0	24.3	4.06	121.1	60.5	120.9	49.7
31	99.0	49.5	99.0	23.7	11.7	23.7	4.17	121.1	60.5	120.9	49.1
30	99.5	49.7	99.5	23.2	11.4	23.2	4.29	121.1	60.6	120.9	48.5
29	100.0	50.0	100.0	22.7	11.2	22.7	4.41	121.1	60.6	120.9	47.9
28	100.5	50.2	100.5	22.2	10.9	22.2	4.53	121.2	60.6	120.9	47.2
27	100.9	50.5	100.9	21.7	10.7	21.7	4.65	121.2	60.6	120.9	46.6
26	101.4	50.7	101.4	21.2	10.5	21.2	4.77	121.2	60.6	121.0	46.1
25	101.8	50.9	101.8	20.8	10.2	20.8	4.90	121.2	60.6	121.0	45.5
24	102.2	51.1	102.2	20.3	10.0	20.3	5.03	121.3	60.6	121.0	44.9
23	102.7	51.3	102.7	19.9	9.8	19.9	5.17	121.3	60.6	121.0	44.3
22	103.1	51.5	103.1	19.4	9.6	19.4	5.31	121.3	60.6	121.1	43.8
21	103.4	51.7	103.4	19.0	9.4	19.0	5.45	121.3	60.6	121.1	43.2
20	103.8	51.9	103.8	18.6	9.1	18.6	5.60	121.3	60.6	121.1	42.6

-- attention: operating limits not reflected in performance table

LEGEND:

Ts-IN: Temperature renewable source - inlet [°C]
Th-OU: Temperature heating - outlet (flow) [°C]
Tc-OU: Temperature cooling - outlet (flow) [°C]
Qh nom: Heating capacity nominal
Qh min: Heating capacity minimal
Qh max: Heating capacity maximal
Pin nom: Power input at nominal heating capacity
Pin min: Power input at minimal heating capacity
Pin max: Power input at maximal heating capacity
COP nom: coefficient of performance at nominal heating capacity
Qc nom: cooling / heat extraction capacity at nominal heating capacity
Qc min: cooling / heat extraction at minimal heating capacity
Qc max: cooling / heat extraction at maximal heating capacity
I nom: Current at nominal heating capacity
EER: energy efficiency ratio at nominal cooling capacity

Operating limits

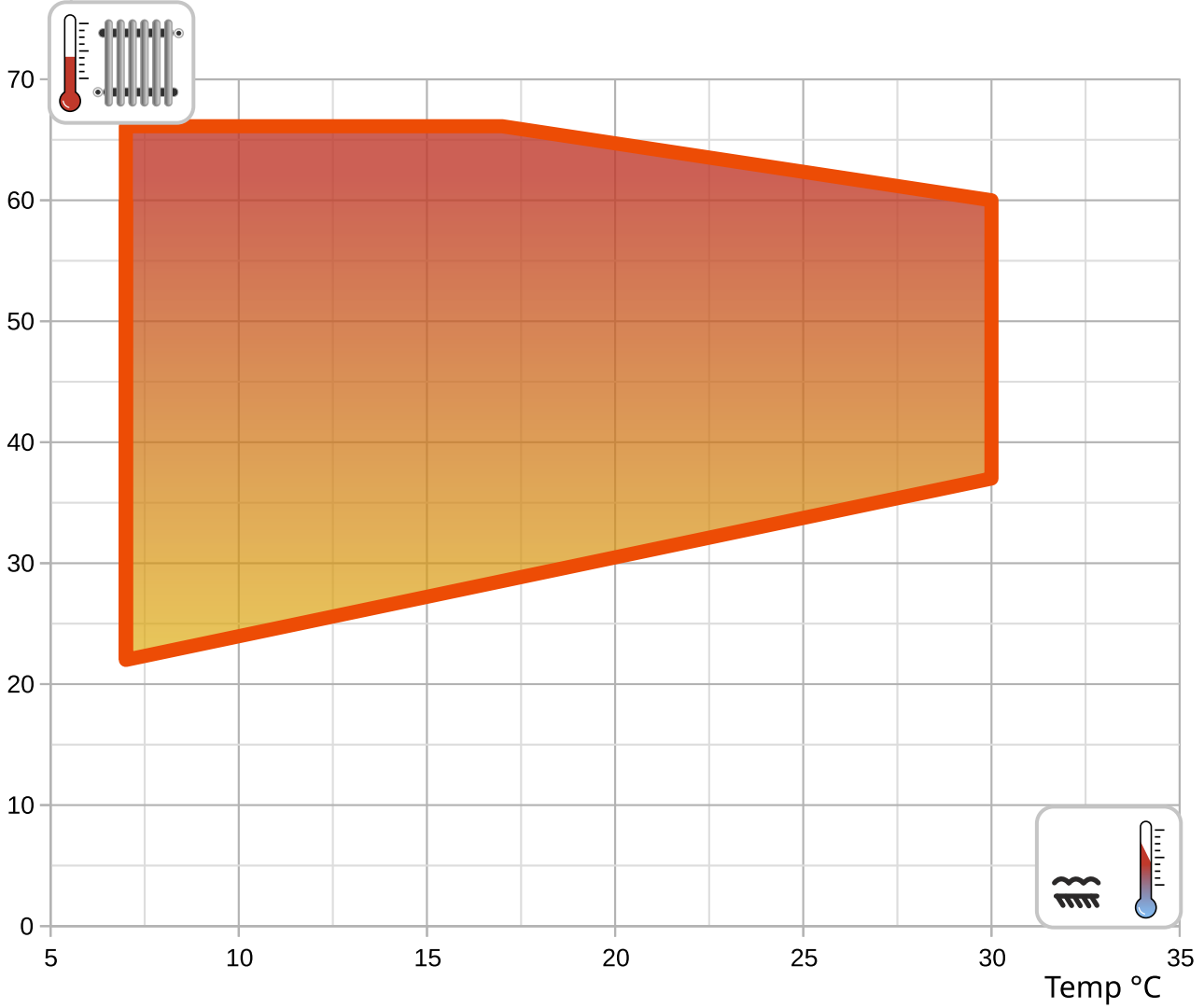

Temp °C

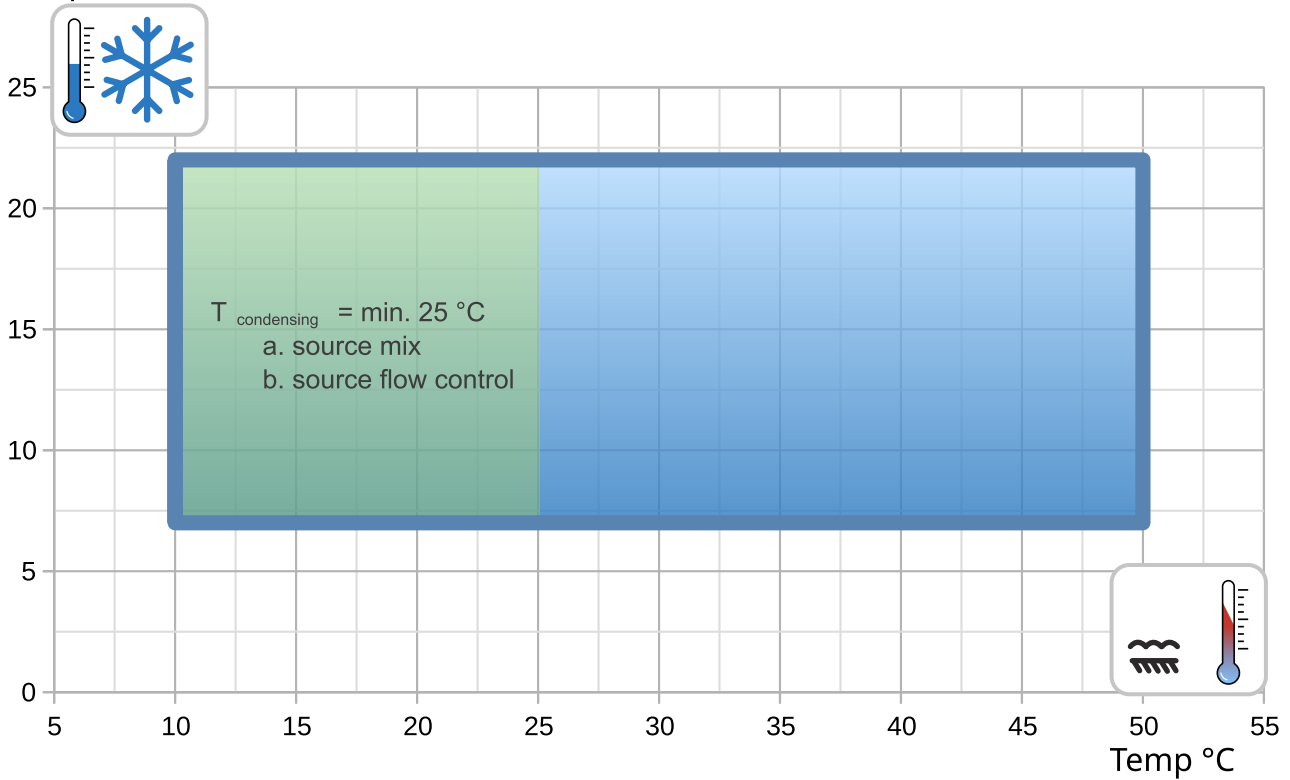

Temp °C

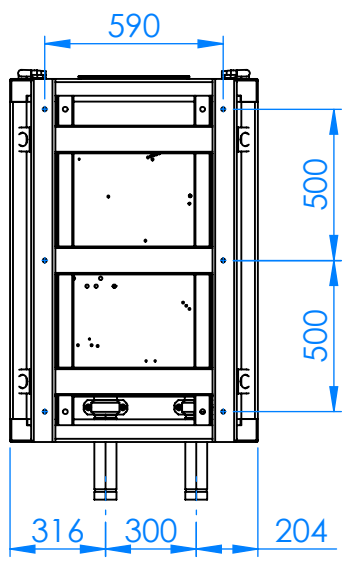
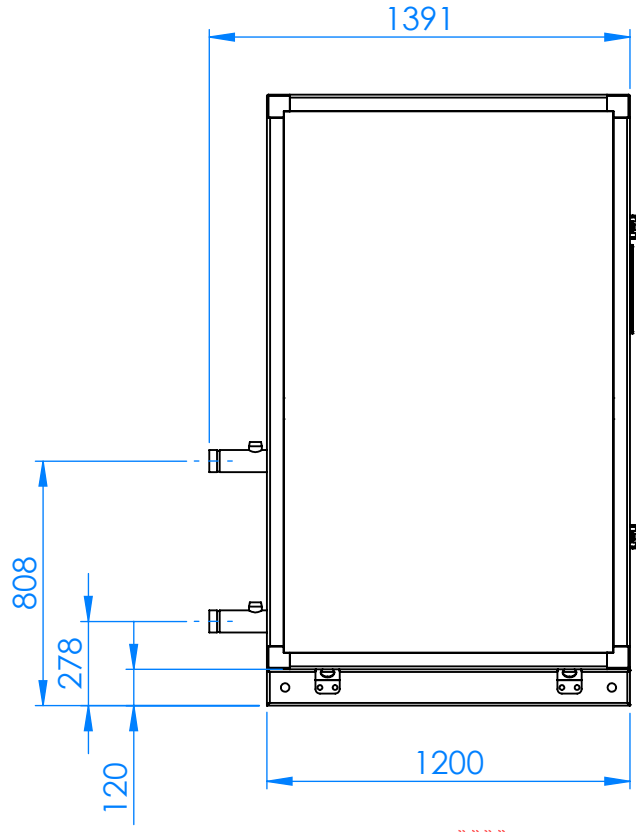
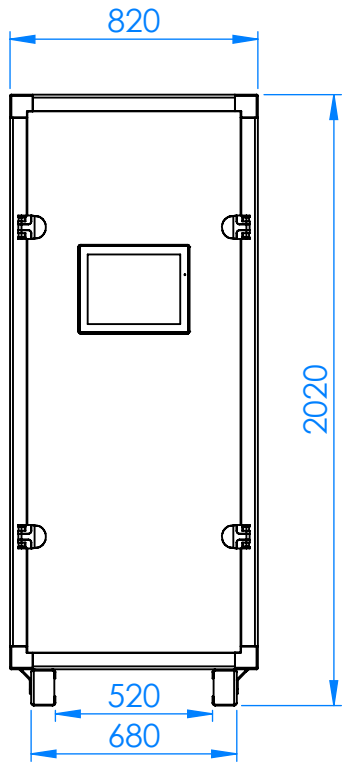

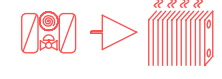
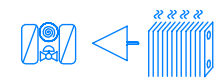
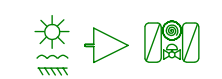

- A - 
- B - 
- D - 
- E - 

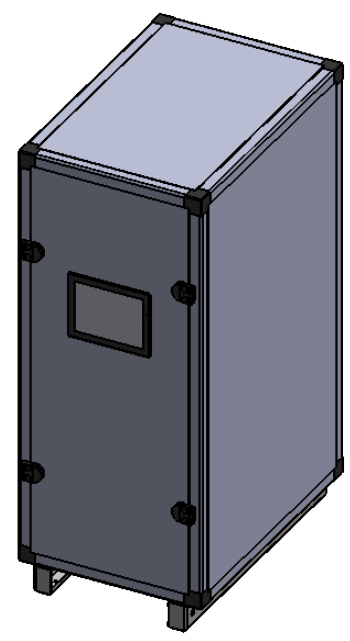
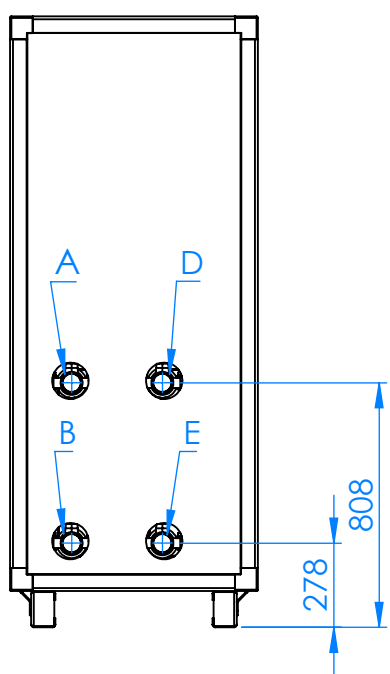

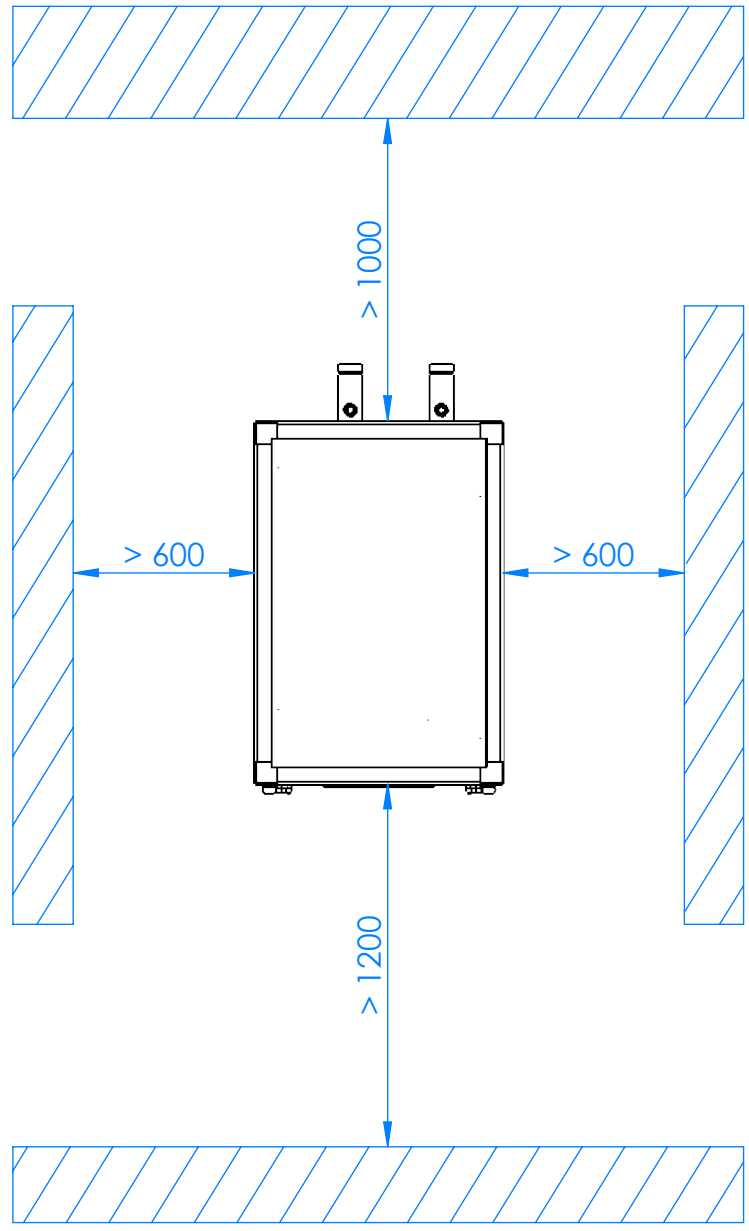

WAMAK TWW 120 EVI HeavyDuty 2L1

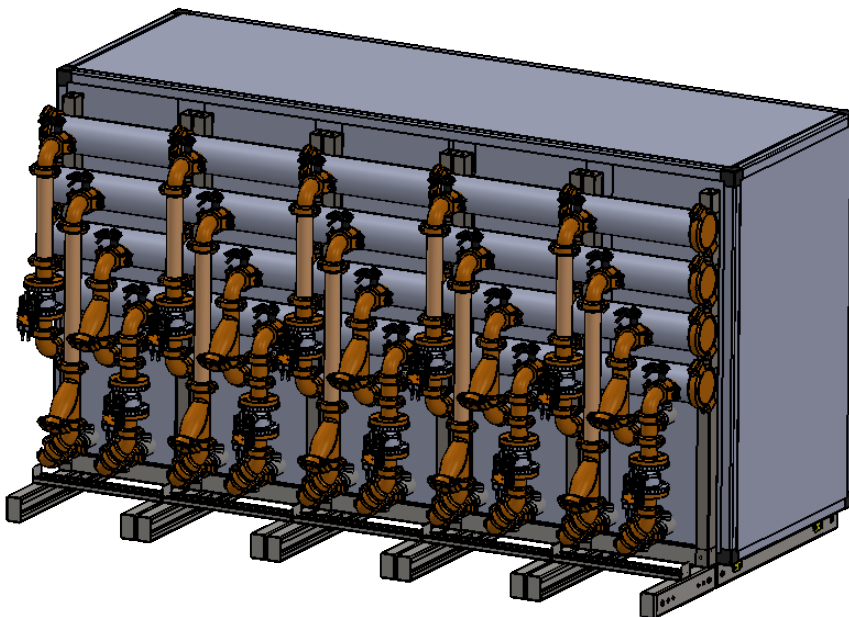
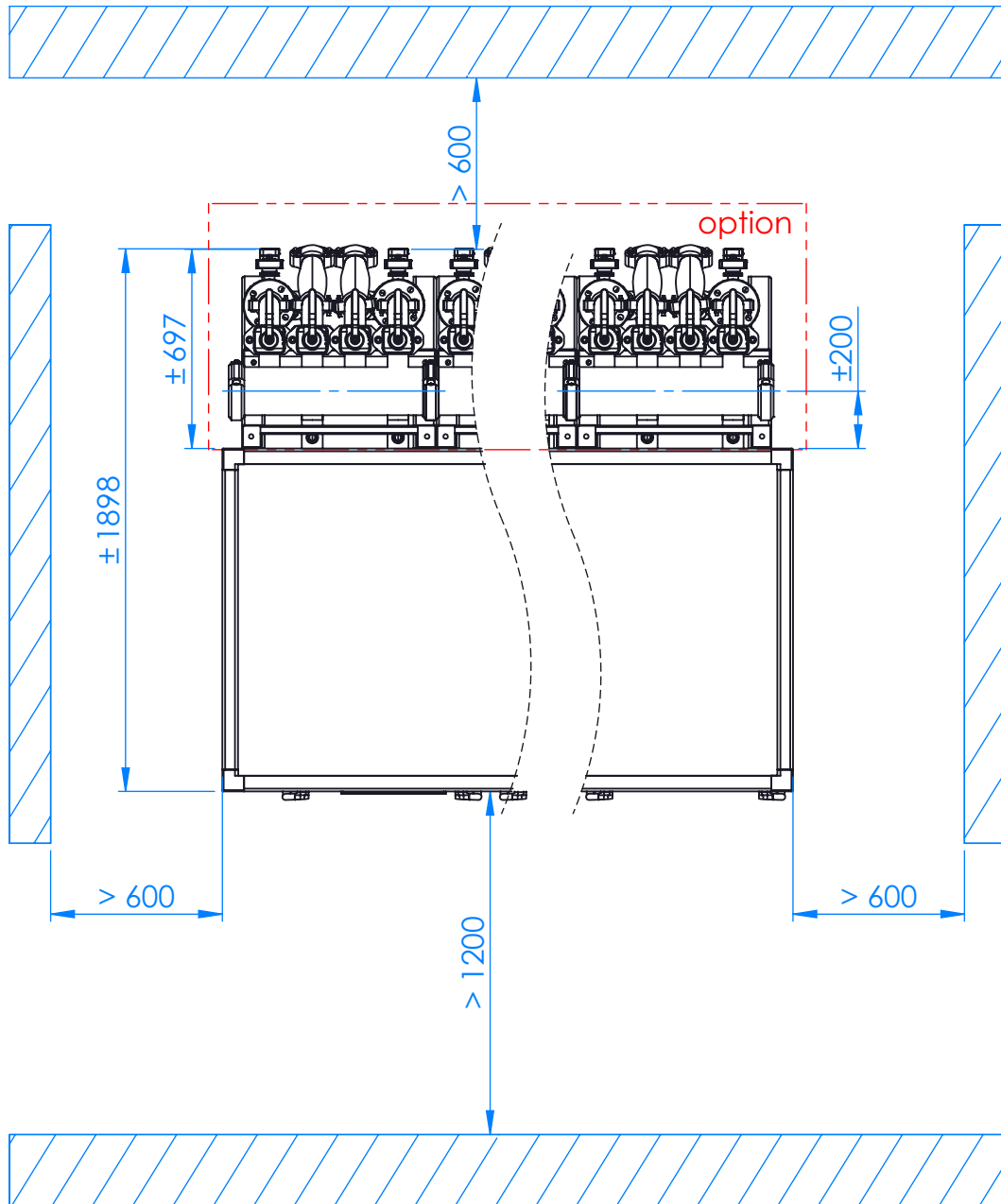

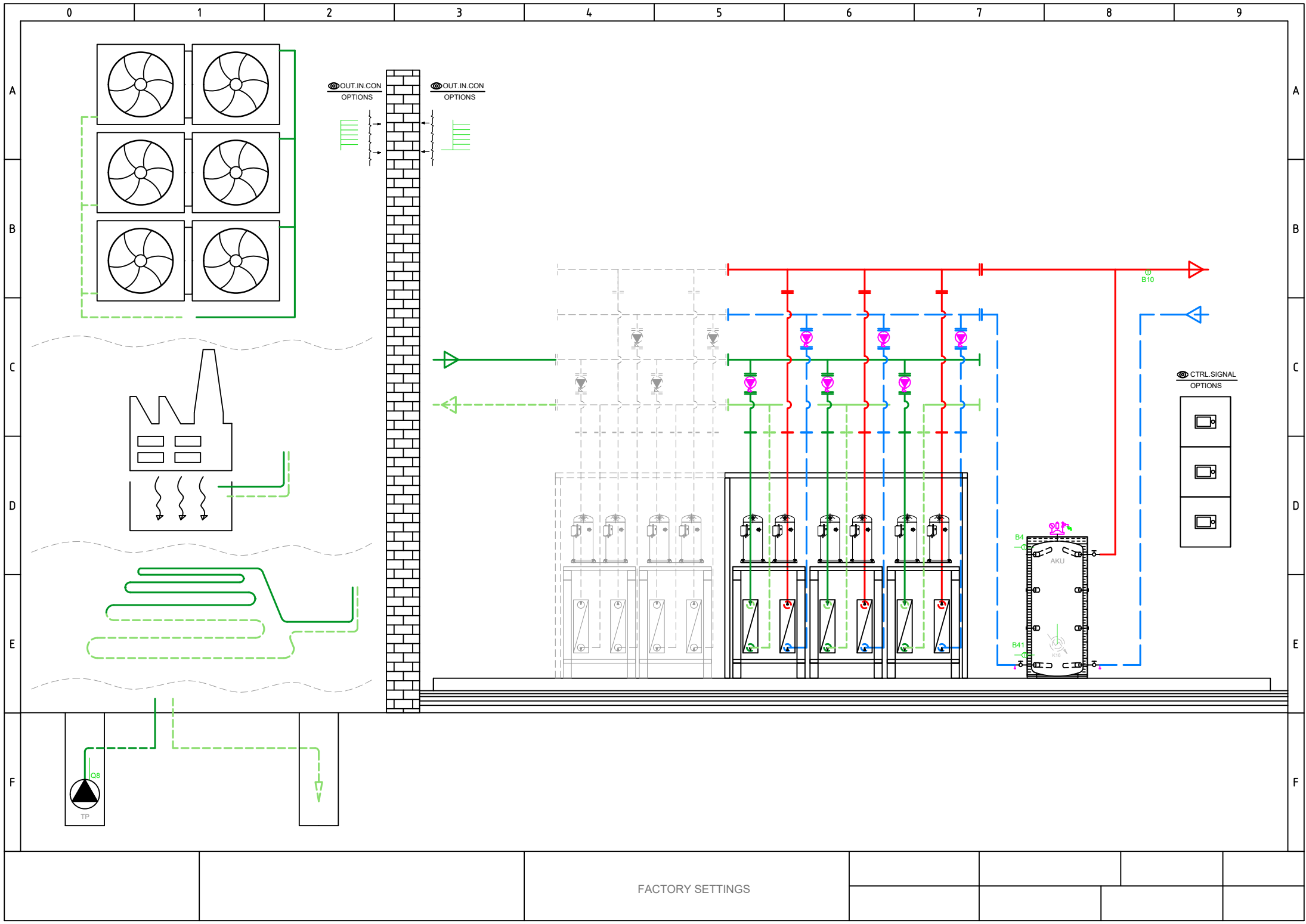

FACTORY SETTINGS

Total: max 6A
1 x QX...: max 2A

Main power supply 230V / 50 Hz
Ground
Neutral conductor

- E9 Low-pressure switch E9
- E10 High-pressure switch E10
- E15 Flow switch source E15
- E24 Flow switch consumers E24
- E6 Electrical utility lock E6
- E12 Overload compressor 2 E12
- E21 Mains supervision E21
- E22 Mains supervision E22
- E23 Mains supervision E23
- E11 Overload compressor 1 E11
- K1 Compressor stage 1 K1

Q8 Source pump Q8

Q9 Condenser pump Q9

K10 Alarm output K10

K40 Crankcase heater K40

K81 Valve evaporator K81

K82 Valve EVI K82

K2 Compressor stage 2 K2

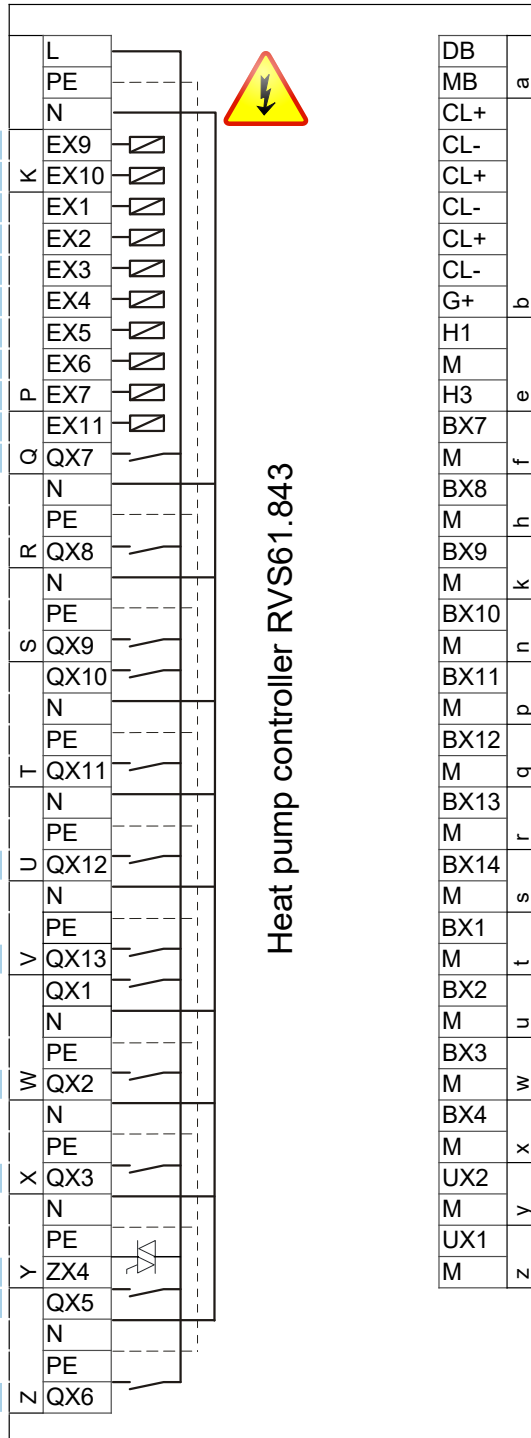

- DB LPB Bus data
- MB LPB Bus GND
- CL+ Room unit QAA...
- CL- Room unit QAA...
- CL+ Room unit QAA... 2.
- CL- Room unit QAA... 2.
- CL+ Room unit QAA... 3.
- CL- Room unit QAA... 3.
- G+ 12V supply → OUT
- H1
- M
- H3 Consumer request VK1
- BX7 B81 Hot-gas sensor K1 B81
- M
- BX8
- M
- BX9
- M
- BX10 B21 HP flow sensor B21
- M
- BX11
- M
- BX12 B71 HP return sensor B71
- M
- BX13 B91 Source inlet sensor B91
- M
- BX14 B84 Source outl sens B92/B84
- M
- BX1
- M
- BX2
- M
- BX3 B83 Refrig sensor liquid B83
- M
- BX4 B82 Hot-gas sensor K2 B82
- M
- UX2 Condenser pump Q9
- M
- UX1 0..10 V Signal
- M
- Z 0..10 V Signal

- AVS75.390
- AVS75.391
- AVS75.370

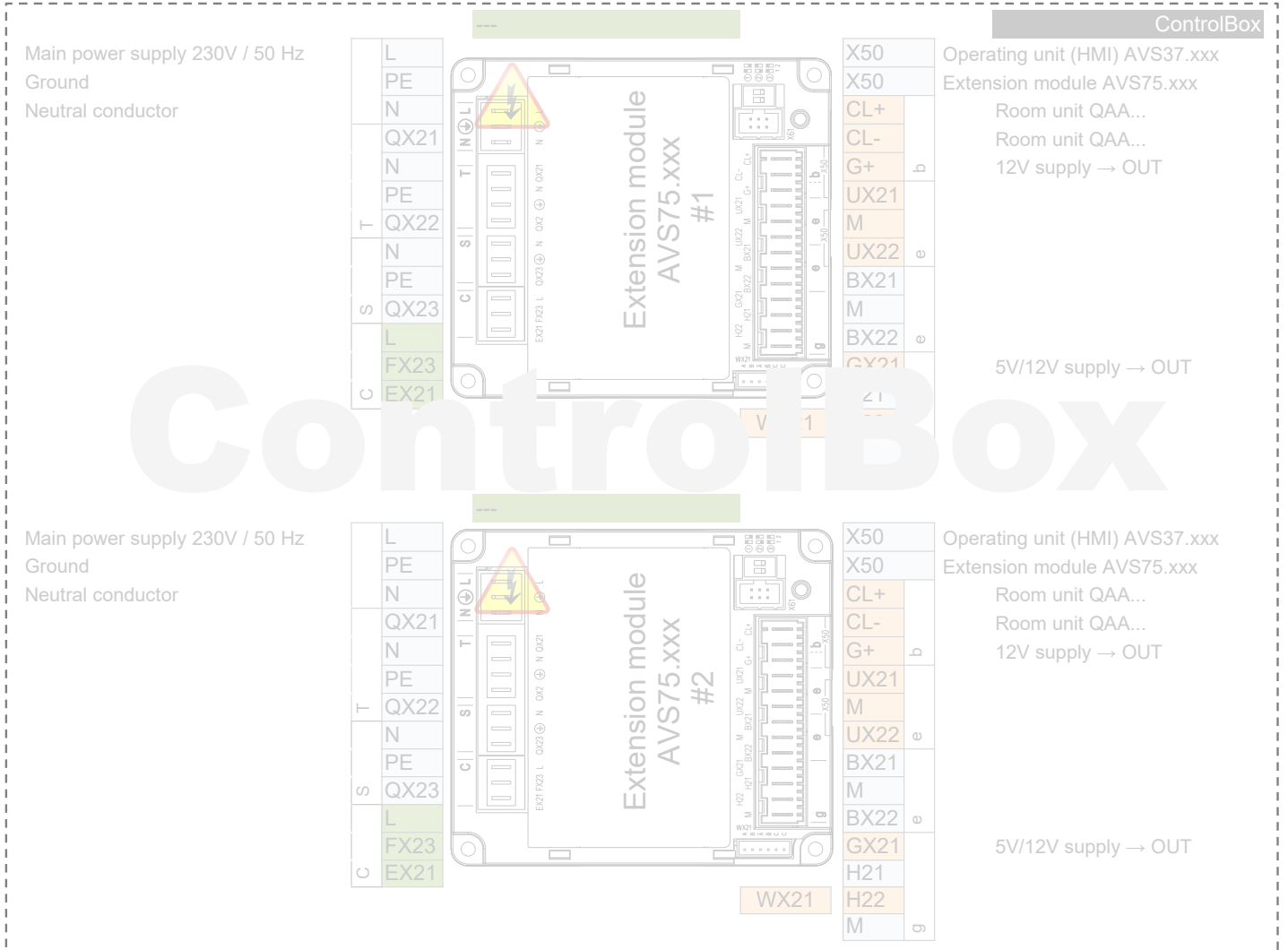

HEAT PUMP

EXTERNAL
INTERNAL

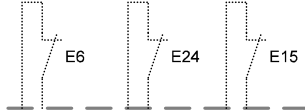
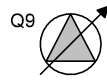
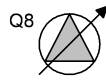

K1

K2

K82

K81

K40

K10

Q8 UX1

Q9 UX2

E11
KRW1
F1K
E11

E12
KRW2
F2K
E12

E6

E24
Q9.ERR
F1S
E24

E15
Q8.ERR
F1Z
E15

E10
E9

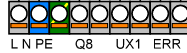
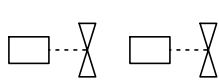

230V,50Hz
max 6A



230V,50Hz
max 6A



DO

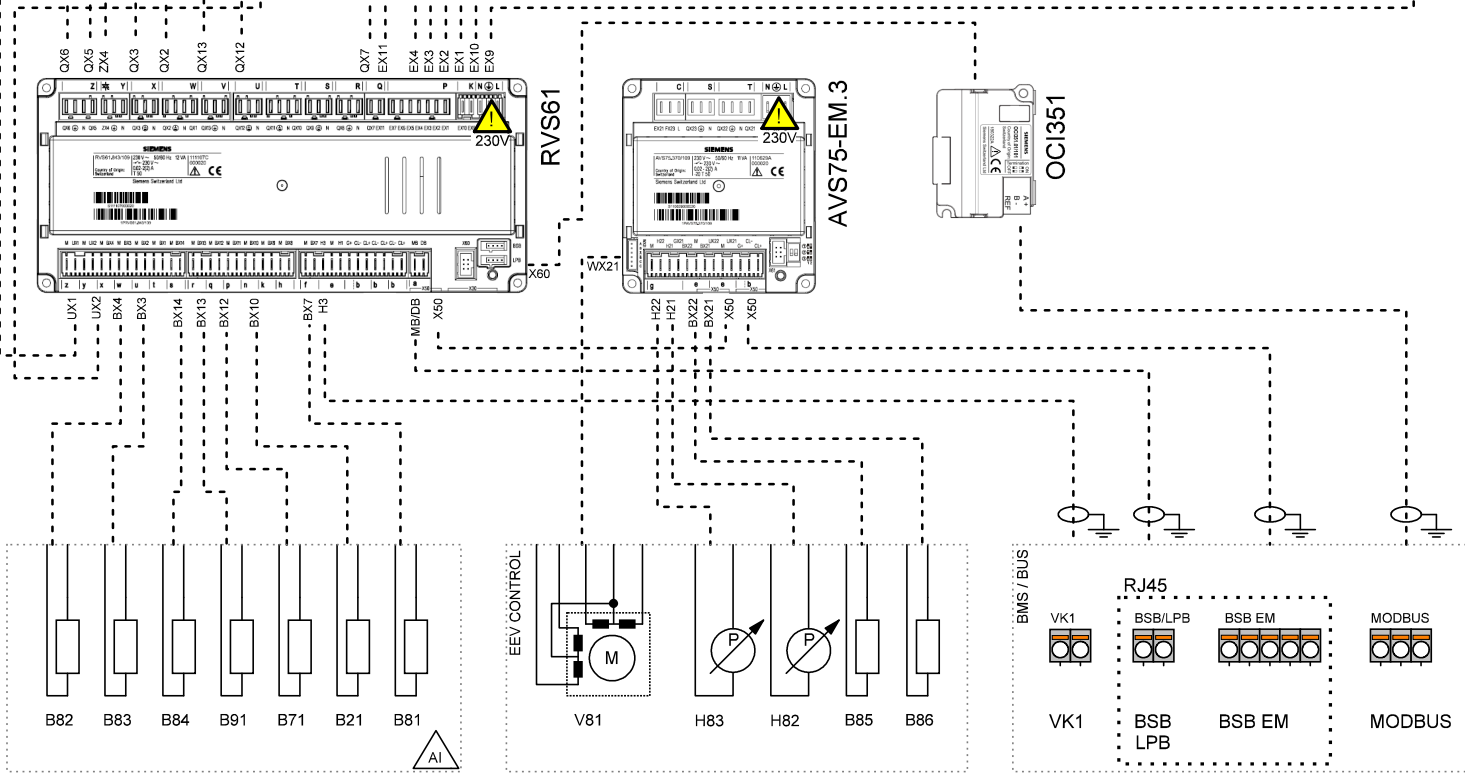
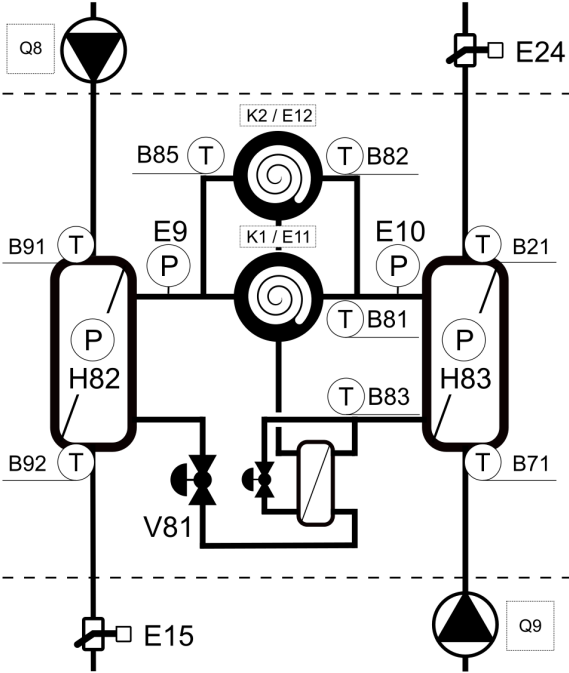

PWR SPLY: 3~ 400V, 50 Hz
CTRL: 1~ 230V, 50 HZ

Company	Title	Version / Note	Number	Created by	Date	Page
	TBW-TWW	05/2024				1

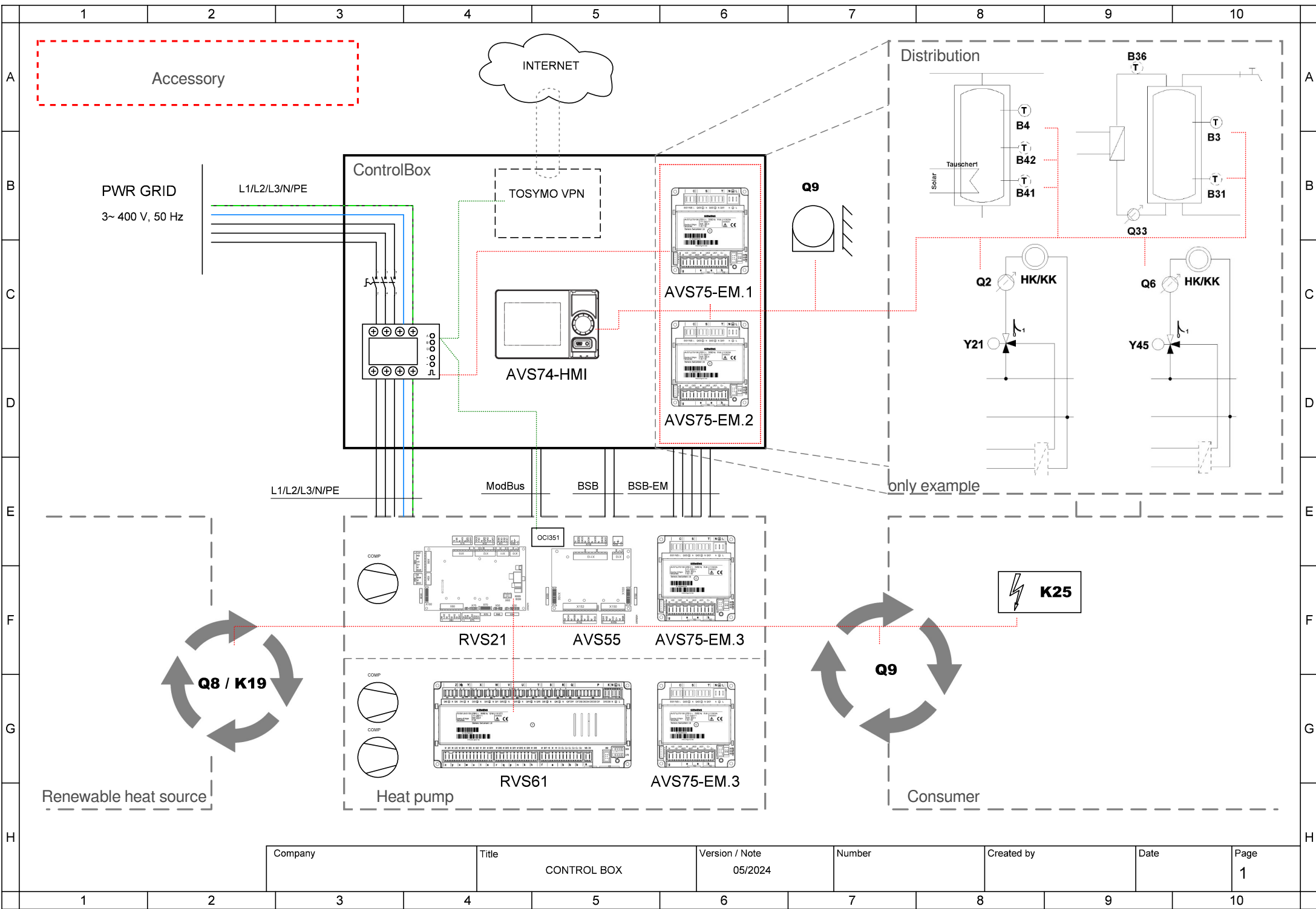

Company	Title	Version / Note	Number	Created by	Date	Page
	CONTROL BOX	05/2024				1

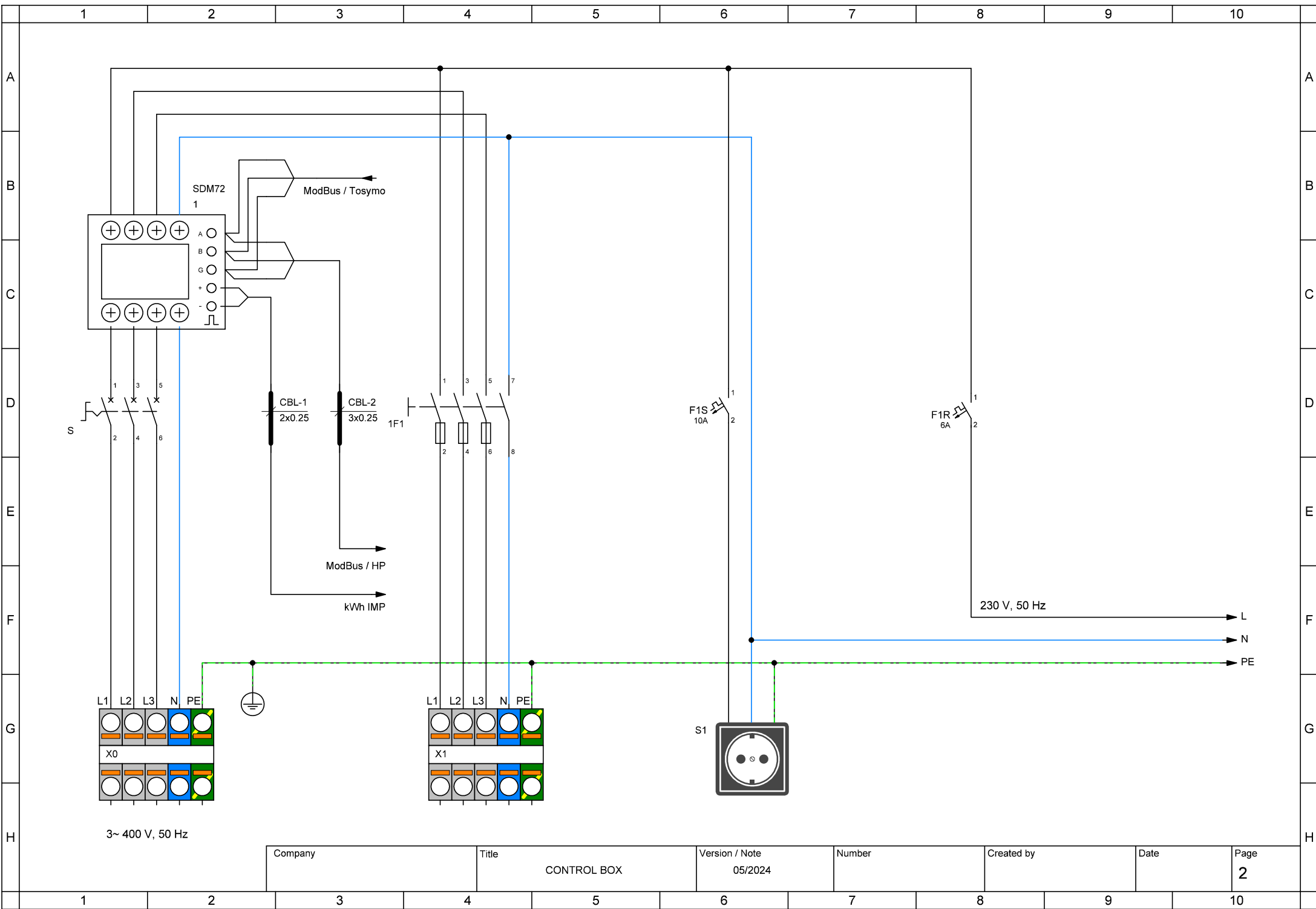

Company	Title	Version / Note	Number	Created by	Date	Page
	CONTROL BOX	05/2024				2

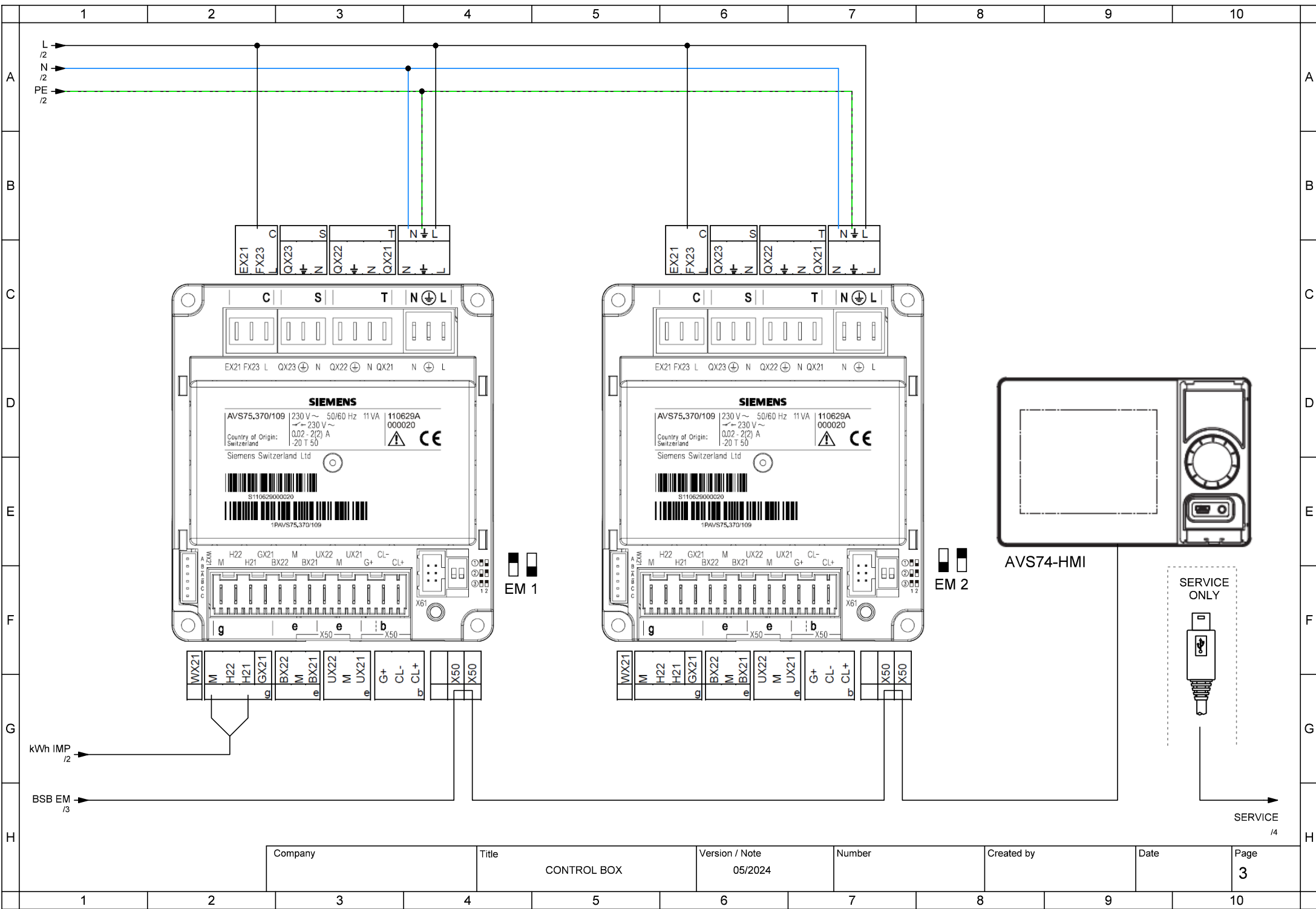

Company	Title	Version / Note	Number	Created by	Date	Page
	CONTROL BOX	05/2024				3

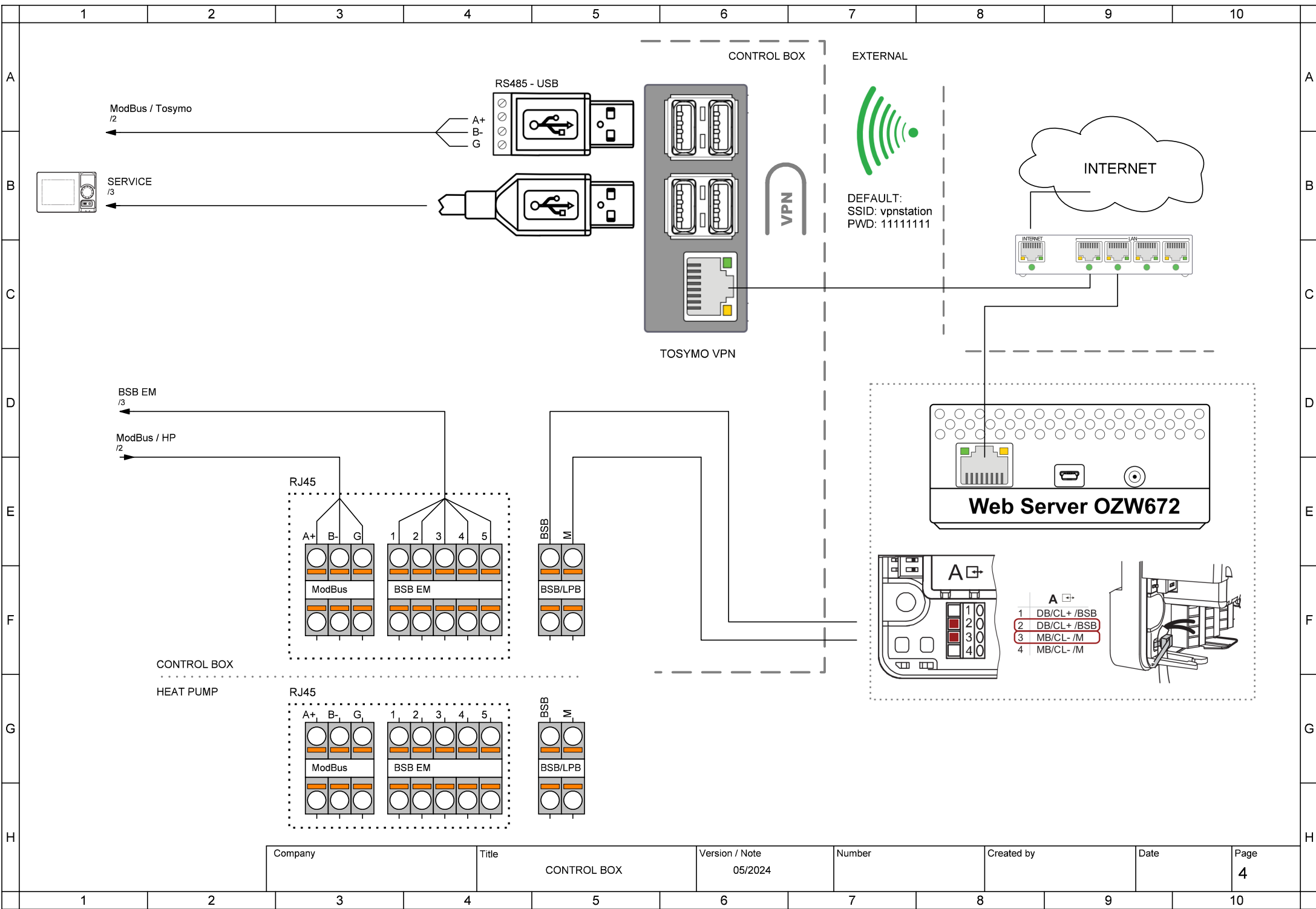

- AVS75.390
- AVS75.391
- AVS75.370

- AVS75.370**
 Main power supply 230V / 50 Hz
 Ground
 Neutral conductor
Y1 Mixing valve Open

Y2 Mixing valve Close

Q2 Heat circuit pump HC1 Q2

L Phase 230V
E61 Smart grid E61

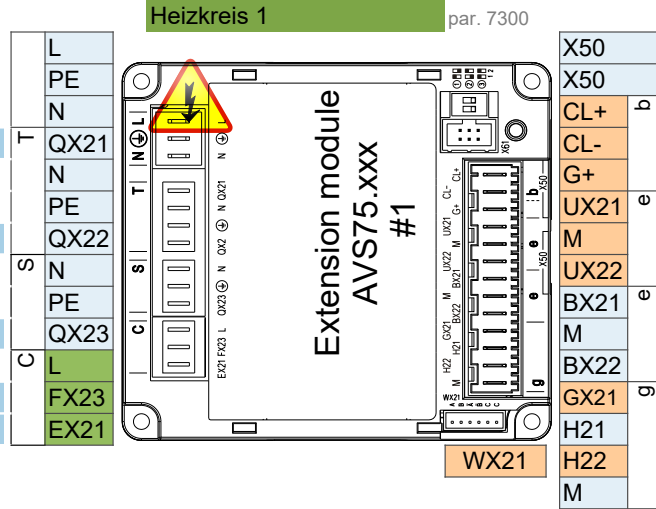

- Extension module AVS75.xxx
 Room unit QAA...
 Room unit QAA...

B1 Flow sensor 1

 Pulse count

- AVS75.370**
 Main power supply 230V / 50 Hz
 Ground
 Neutral conductor
Q3 DHW ctrl elem Q3

K6 El imm heater DHW K6

Q6 Heat circuit pump HC2 Q6

L Phase 230V
E62 Smart grid E62

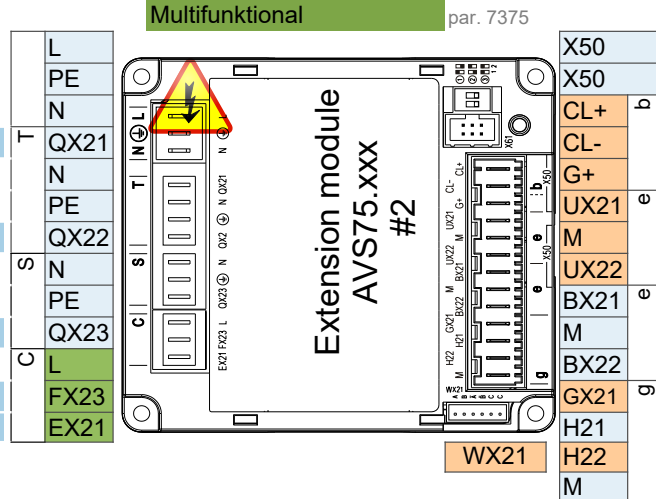

- Operating unit (HMI) AVS37.xxx
 Extension module AVS75.xxx
 Room unit QAA...
 Room unit QAA...

B3 DHW sensor B3

B4 Buffer sensor B4

- Main power supply 230V / 50 Hz
 Ground
 Neutral conductor

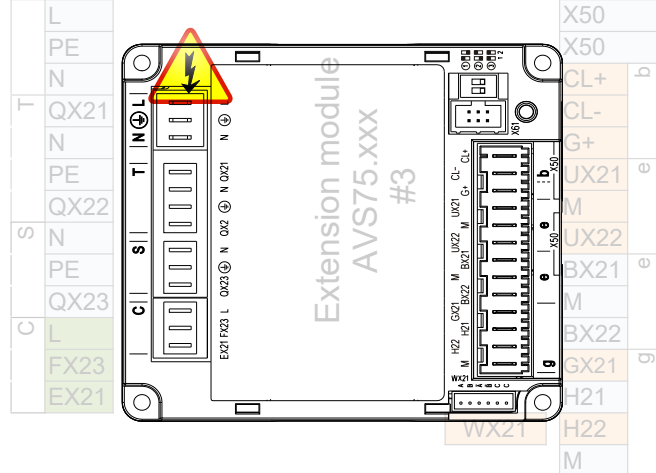

- Operating unit (HMI) AVS37.xxx
 Extension module AVS75.xxx
 Room unit QAA...
 Room unit QAA...

Attention: Extension module 3 is inside the heat pump

Control connection options

1 ControlBox

ControlBox, with two built-in extension modules, enables numerous options for application control on the consumer side behind the heat pump. For more, see the ControlBox schematic and the application diagrams sheet.

2 Fix flow temperature setpoint - On / Off dry (potential free) contact

2 wire shielded cable 2 x 0.5 mm² - Setpoint = 45°C (editable by param. 1859)

Connection terminal - see wiring diagram

3 Analog 0..10V flow temperature setpoint control

2 wire shielded cable 2 x 0.5 mm² - Setpoint: 0V = 16°C ~ 10V = 60°C (editable in parameter set)

Connection terminal - see wiring diagram

4 ModBus RTU communication command

3 wire shielded cable min. 3 x 0.25mm²

For ModBus mapping table contact technical support

5 MQTT IoT communication protocol

For more information contact technical support