

 **WAMAK**

BW 42 EVI



High flow temperature heat pump
brine - water

High flow temperature heat pump brine - water

High temperature compact heat pump with stable frame construction and flexible outputs. Double high-absorption suspension with sylomer pads and adjustable feet base plates ensure low noise and vibration levels of the hermetic SCROLL compressor.

Stainless steel plate heat exchanger (1.4401) for heating circuit. Stainless plate plate heat exchanger (1.4401) for source circuit. Electrical switchboard with integrated safety elements and equithermal controller of the heat pump is located under the upper lid. With electronic starter via built-in soft starter and electronic expansion valve control with autoadaptivity.

Frame construction with a massive base plate on adjustable legs. Covering the epoxy-coated unit. The multi-layer sound insulation and vibration-eliminating profiles are glued from the inside of the cover. Equithermal, digital control of the heat pump with integrated cooling control function (passive cooling). For controlling one heating circuit with mixing unit, for one heating circuit without a mixing unit. Using the cooling function (passive cooling) and the cooling circuit with mixing unit. Temperature regulation for DHW storage tank and control of electrical auxiliary heating. Simple extension of control up to 3 heating / cooling circuits via expansion modules or up to 16 circuits via system controllers. The standard version also includes solar control as well as the possibility of cascading up to 16 devices.

Full-text control menu with features dependent on user instructions, information texts and status output signal. Diagnostic system with record history of operation. External temperature sensor, hotgas sensor, liquid refrigerant temperature sensor, heat pump flow and return temperature sensor as well as source output sensor, source return sensor, and hot water sensor. Optionally available with ModBus module as well WebControl control and monitoring via the Internet.

Optionally available with ModBus module as well WebControl control and monitoring via the Internet.

Technical information - heat pump

Type :	BW 42 EVI	latest data update :	
Article code :	WA001318	Language :	English

Nominal performance data according to EN 14511

Heating capacity :	42.22 kW	Input :	9.18 kW
Refrigerating capacity :	33.04 kW	COP :	4.6

* Data at conditions B0°C/W35°C

Operating temperature limitations

Source temperature minimal :	-5°C	Flow temperature minimal :	+20°C
Source temperature maximal :	+25°C	Flow temperature maximal :	+65°C

Mechanical data

Width :	mm	Weight inside :	265 kg
Depth :	mm		
Height :	mm		

Noise emissions

Noise emissions inside Lp (1m) :	45 dB(A)
------------------------------------	----------

Refrigerant circle parameters

Refrigerant :	R410A	Orifice inside :	EEV
Refrigerant volume :	5.7 kg	Orifice economizer :	EEV

Pipe dimensions, flow rates , pressure drops

Connecting dimensions - primary side :	VIC 2.1/2 "	Pressure drop - primary side :	max 20 kPa
Connecting dimensions - secondary side :	2 "	Pressure drop - secondary side :	max 20 kPa
Flow - primary side :	10.04 m ³ /hour	Recommended ΔT source :	3 K
Flow - secondary side :	7.3 m ³ /hour	Recommended ΔT consumer :	5 K
Maximum water pressure consumer :	6 bar		

Electrical parameters

Main connection cable - dimension :	5x6 mm ²	Current - nominal :	21.64 A
Primary side cable - dimension :	3x0.75 mm ²	Current - maximal :	33 A
Voltage :	3 x 400 V	Softstart :	MCD 201
Fuze :	40 A	Starting current :	58.42 A

Features

Condenser circulator installed :	MAGNA 1 32-120	Installed HP controller :	SIEMENS RVS 21
Source circulator installed :	MAGNA 1 32-100	Control of mixed heating circuit :	Yes
Bivalent heater installed :	No	Control of direct pump heating circuit :	Yes

Three way switching valve in delivery : No Active cooling : optional

ModBus : with extension module Solar system control : Yes

WebControl : with WebServer-Module

!!! Technical data subject to change without notice !!!

Source	Heating capacity / flow temperature (kW)				Power input / flow temperature (kW)				COP / flow temperature (-)			
	°C	35	45	55	65	35	45	55	65	35	45	55
10	54,38	56,57	56,57	56,24	9,51	12,14	14,77	17,61	5,72	4,66	3,83	3,19
9	53,20	54,89	54,89	54,89	9,54	12,14	14,74	17,58	5,58	4,52	3,72	3,12
8	52,35	53,37	53,37	53,53	9,60	12,11	14,70	17,51	5,45	4,41	3,63	3,06
7	51,17	51,85	52,02	52,18	9,59	12,08	14,67	17,45	5,34	4,29	3,55	2,99
6	49,99	50,50	50,66	51,00	9,56	12,05	14,61	17,42	5,23	4,19	3,47	2,93
5	48,47	49,14	49,31	49,82	9,48	12,02	14,58	17,36	5,11	4,09	3,38	2,87
4	47,12	47,79	47,96	48,47	9,43	11,91	14,55	17,30	5,00	4,01	3,30	2,80
3	45,77	46,44	46,78	47,29	9,34	11,76	14,49	17,23	4,90	3,95	3,23	2,74
2	44,58	45,09	45,60	46,27	9,30	11,61	14,45	17,17	4,79	3,89	3,15	2,69
1	43,40	43,91	44,42	45,26	9,26	11,45	14,42	17,11	4,69	3,83	3,08	2,65
0	42,22	42,73	43,40	44,08	9,18	11,30	14,36	17,05	4,60	3,78	3,02	2,59
-1	41,21	41,71	42,39	43,06	9,15	11,28	14,33	16,98	4,51	3,70	2,96	2,54
-2	40,19	40,53	41,27	42,22	9,12	11,27	14,27	16,92	4,41	3,60	2,89	2,50
-3	39,18	39,69	40,19	41,21	9,08	11,26	14,20	16,83	4,32	3,52	2,83	2,45
-4	38,17	38,67	39,35	40,36	9,02	11,25	14,17	16,76	4,23	3,44	2,78	2,41
-5	37,32	37,83	38,50	39,52	8,99	11,21	14,11	16,70	4,15	3,37	2,73	2,37

Operation limits:

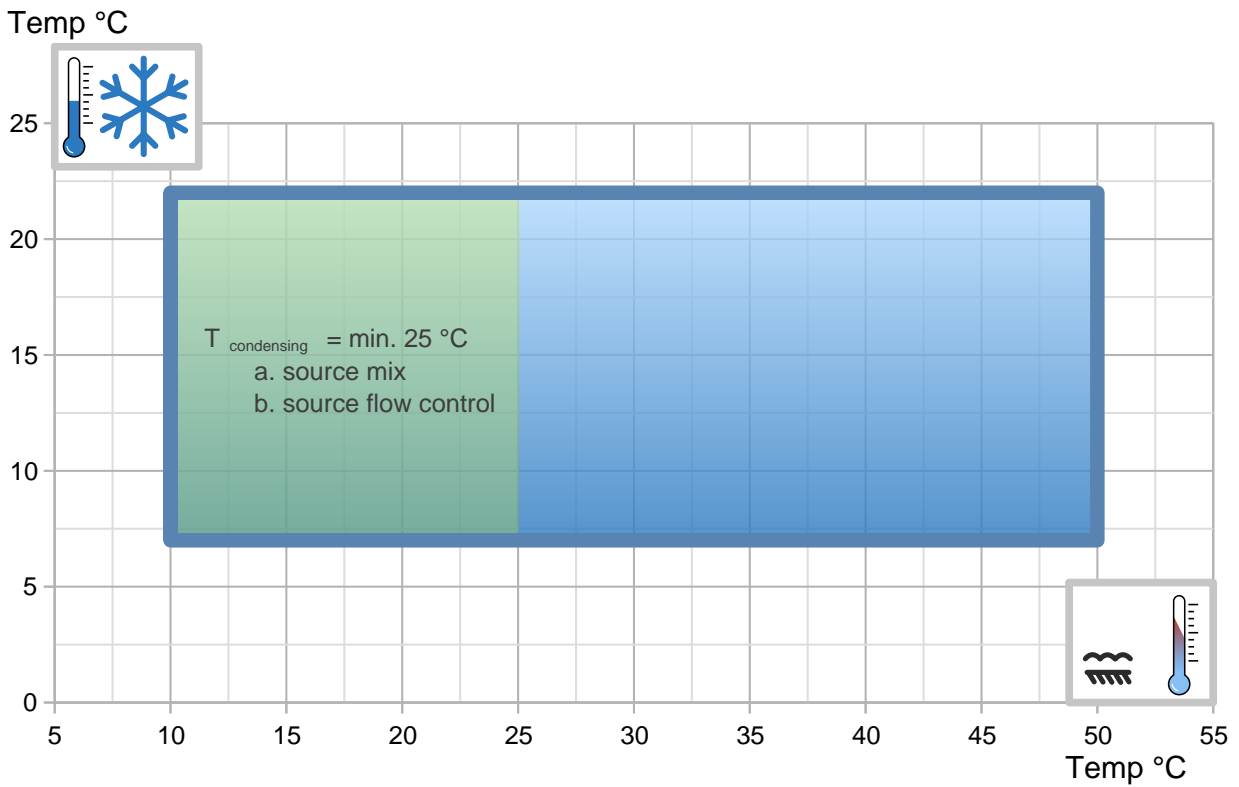
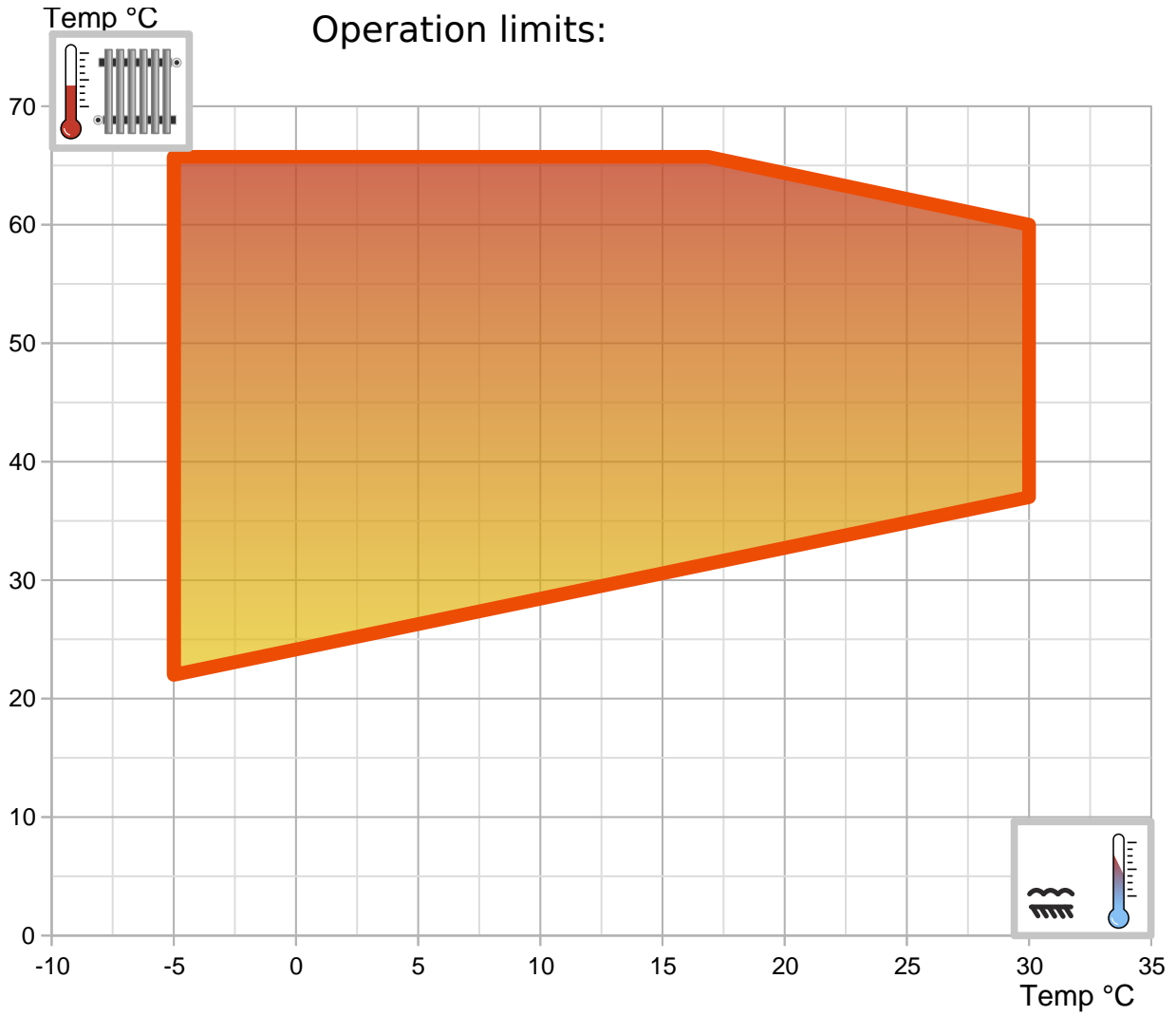

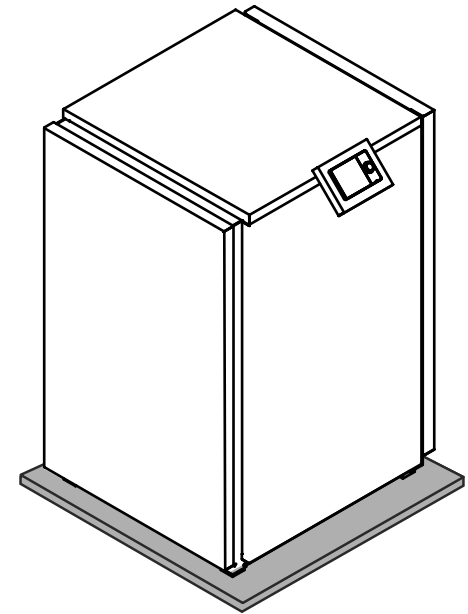
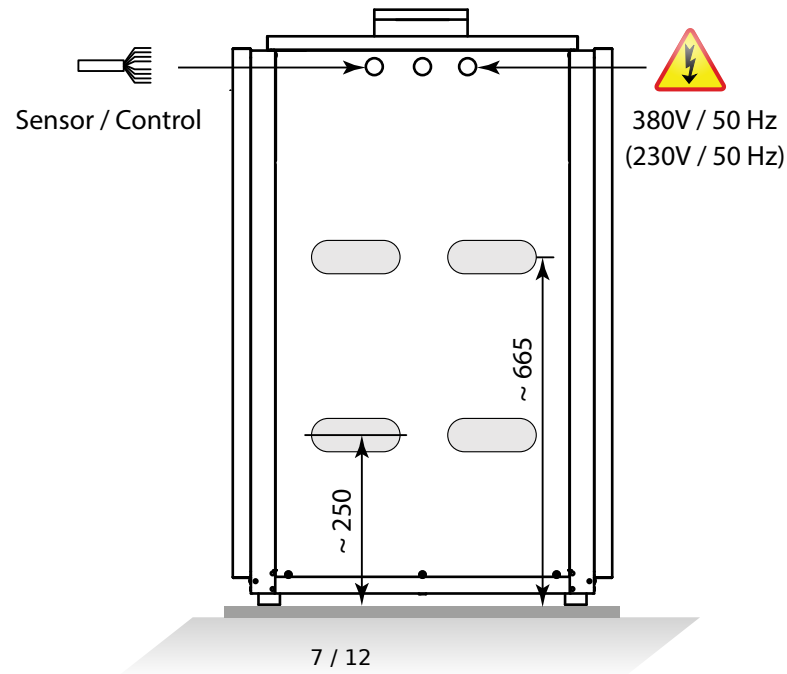
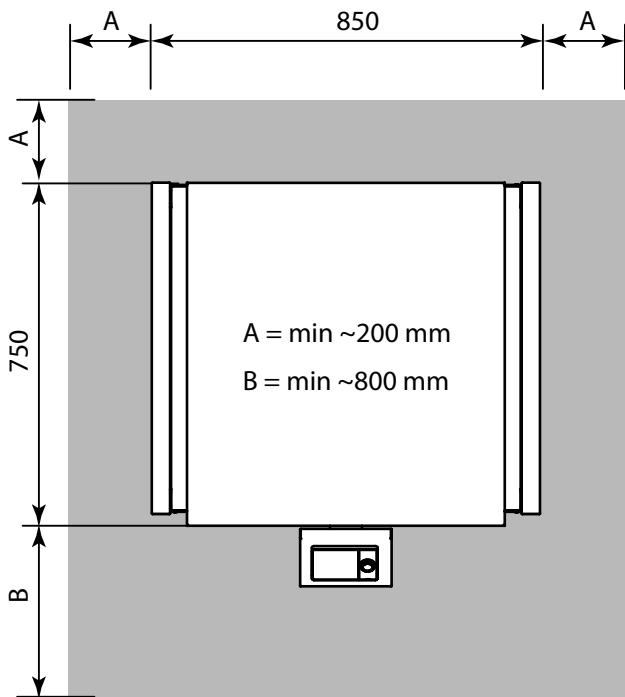
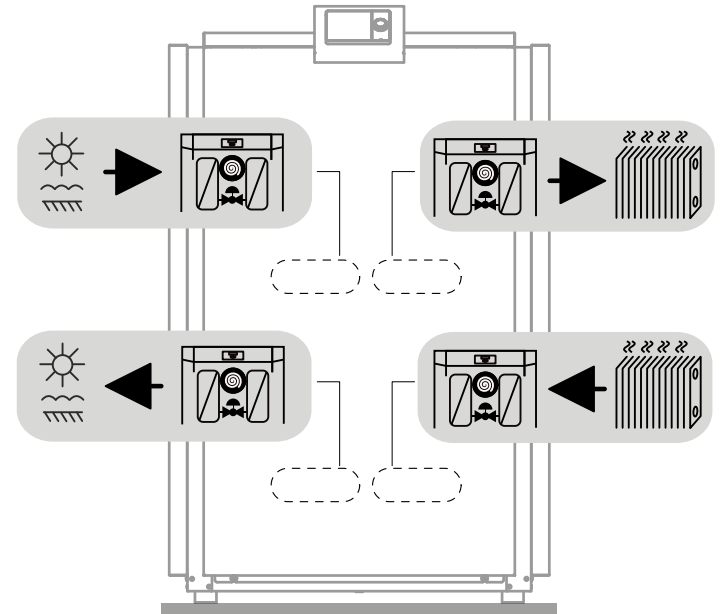
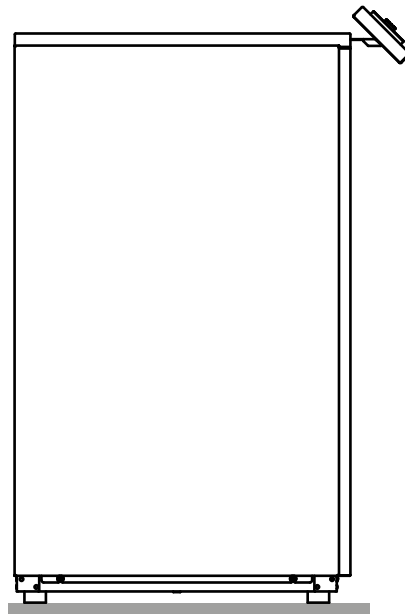
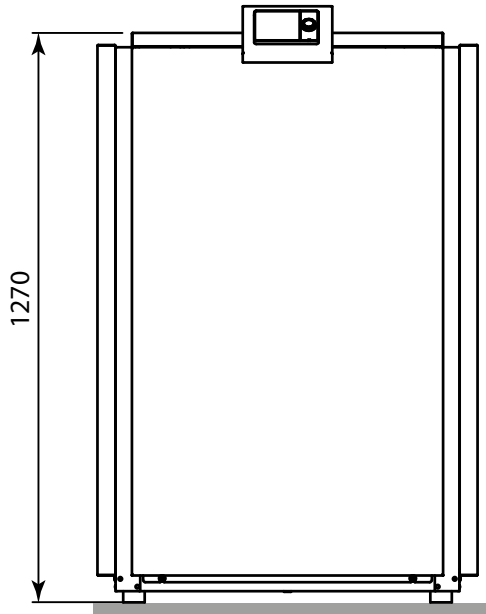

int. code: VN800HT

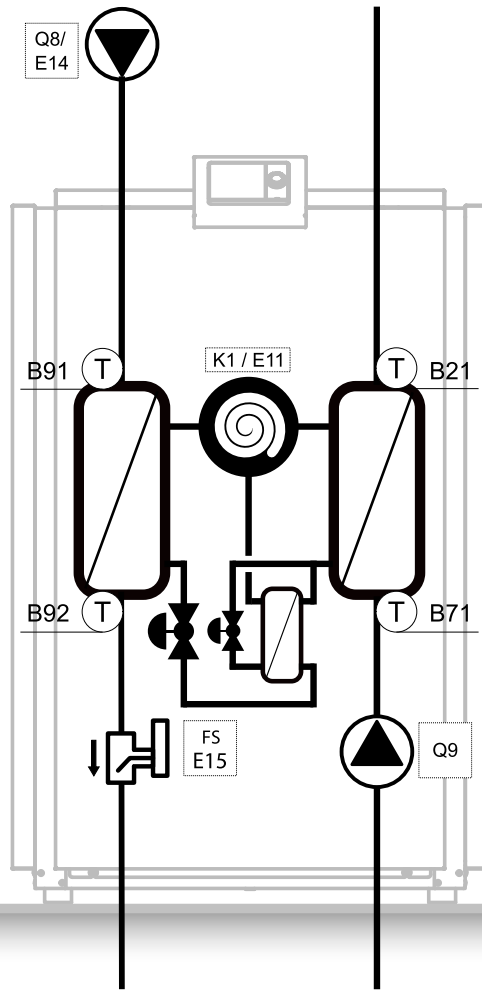

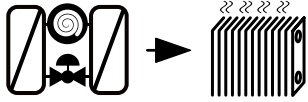

BW 42 EVI

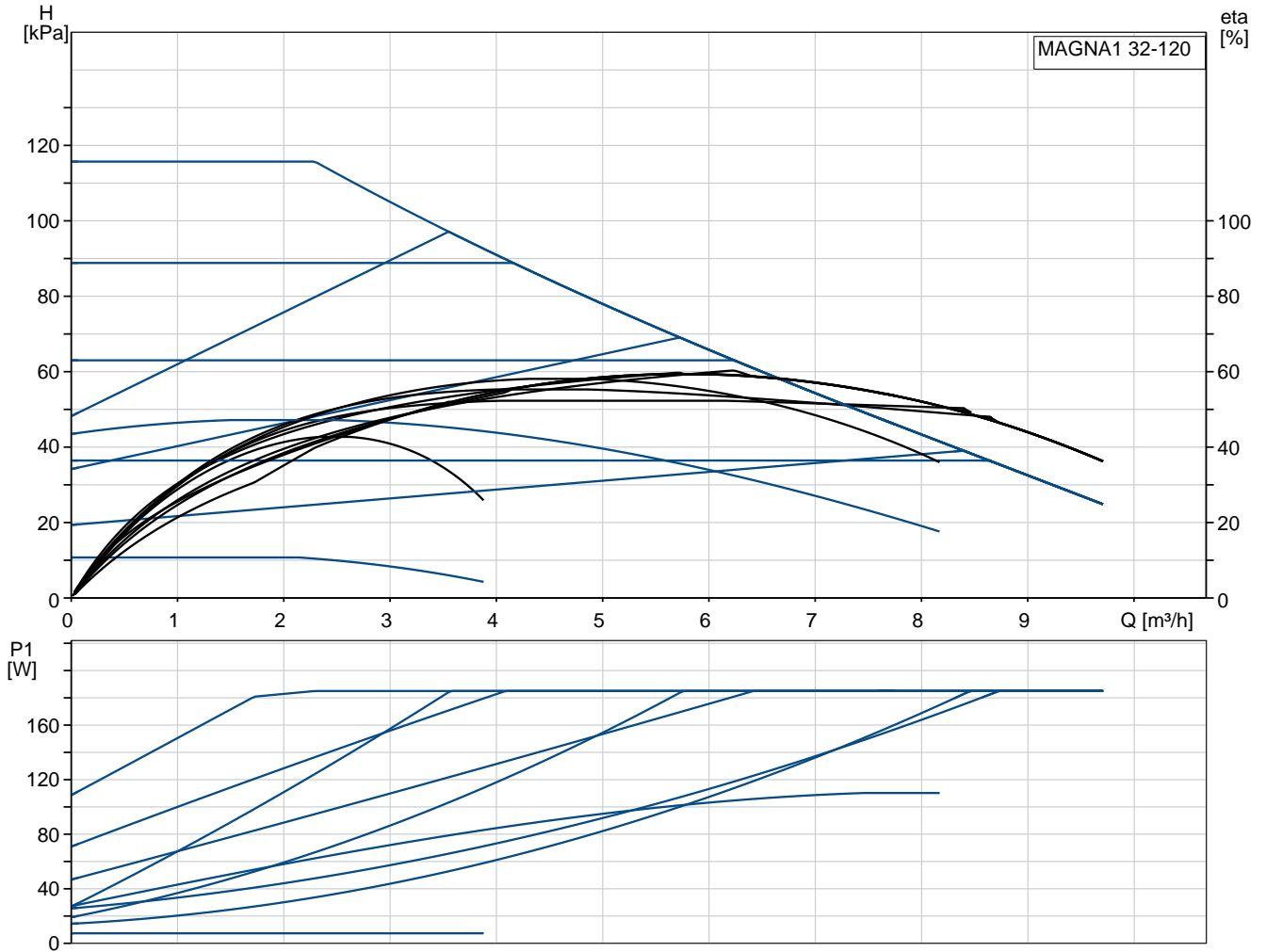

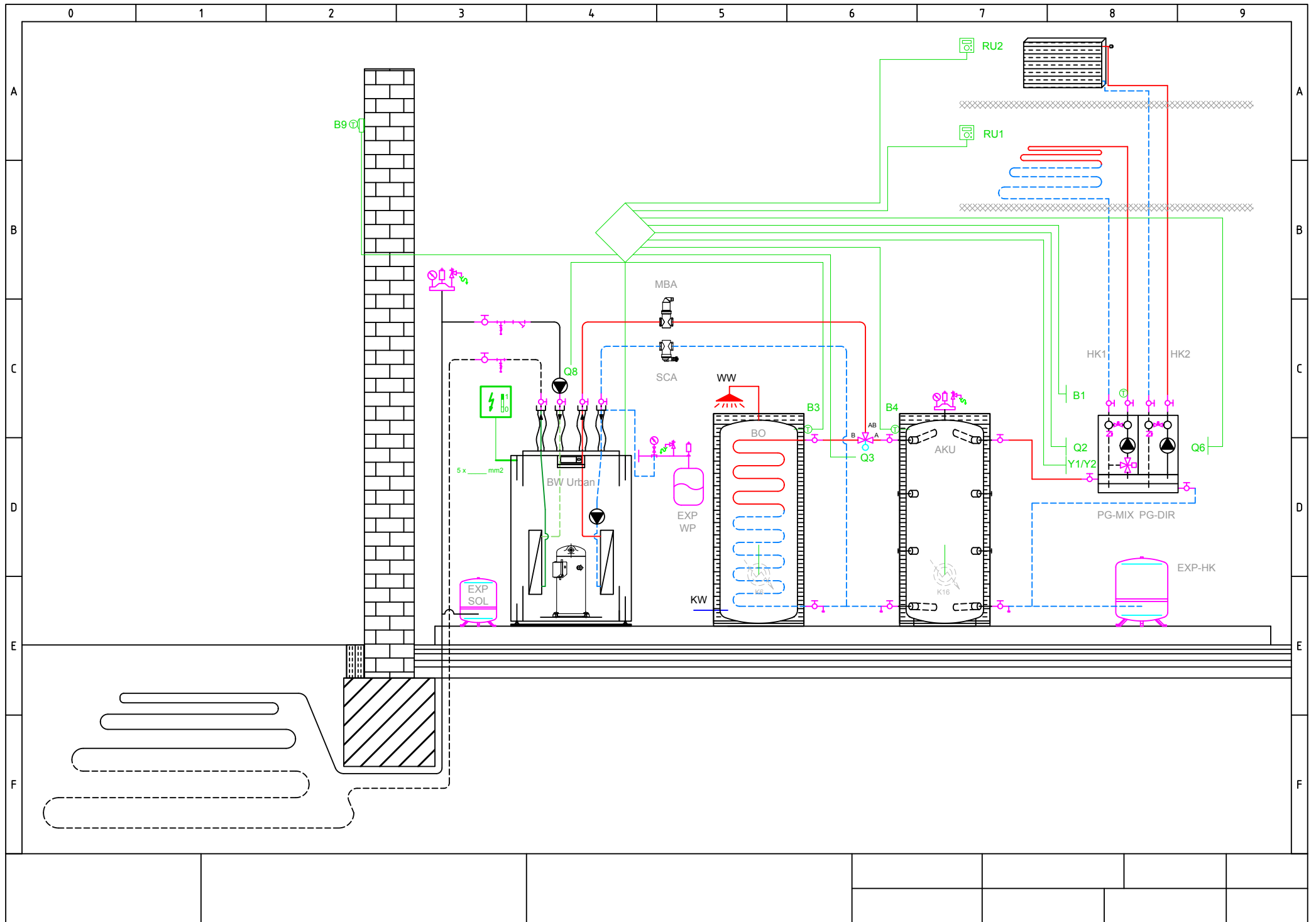



ENERG Y IJA
енергия - ενεργεια IE IA

WAMAK

BW 42 EVI

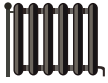

55 °C

35 °C

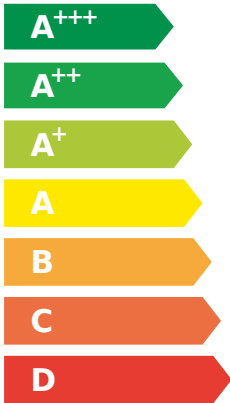

53 dB

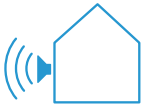

-0 dB

■ 43	■ 42
■ 43	■ 42
■ 43	■ 42
kW	kW



2019

811/2013

BW 42 EVI

ErP Data

	55 °C	35 °C
Energy class	A+	A+++
η [%]	146	182
P_{rated} [kW]	43	42
Q_{HE} [kWh/y]	23709	18959
SCOP [-]	3.66	4.56
$T_{bivalent}$ [°C]	0	0

	A+	A+++
Energy class	A+	A+++
η [%]	130	182
P_{rated} [kW]	43	42
Q_{HE} [kWh/y]	31998	22849
SCOP [-]	3.25	4.54
$T_{bivalent}$ [°C]	0	0

	A+++	A+++
Energy class	A+++	A+++
η [%]	182	182
P_{rated} [kW]	43	42
Q_{HE} [kWh/y]	12275	12260
SCOP [-]	4.54	4.54
$T_{bivalent}$ [°C]	-	-

CONTROLLER



+ QAA55/75	class VII	3.5% ↓
- QAA55/75	class III	1.5% ↓



SERVICE